

TiS55+/TiS75+ Thermal Imager

Users Manual



October 2020

© 2020 Fluke Corporation. All rights reserved.

Specifications are subject to change without notice.

All product names are trademarks of their respective companies.

LIMITED WARRANTY AND LIMITATION OF LIABILITY

Each Fluke product is warranted to be free from defects in material and workmanship under normal use and service. The warranty period is two years and begins on the date of shipment. Parts, product repairs, and services are warranted for 90 days. This warranty extends only to the original buyer or end-user customer of a Fluke authorized reseller, and does not apply to fuses, disposable batteries, or to any product which, in Fluke's opinion, has been misused, altered, neglected, contaminated, or damaged by accident or abnormal conditions of operation or handling. Fluke warrants that software will operate substantially in accordance with its functional specifications for 90 days and that it has been properly recorded on non-defective media. Fluke does not warrant that software will be error free or operate without interruption.

Fluke authorized resellers shall extend this warranty on new and unused products to end-user customers only but have no authority to extend a greater or different warranty on behalf of Fluke. Warranty support is available only if product is purchased through a Fluke authorized sales outlet or Buyer has paid the applicable international price. Fluke reserves the right to invoice Buyer for importation costs of repair/replacement parts when product purchased in one country is submitted for repair in another country.

Fluke's warranty obligation is limited, at Fluke's option, to refund of the purchase price, free of charge repair, or replacement of a defective product which is returned to a Fluke authorized service center within the warranty period.

To obtain warranty service, contact your nearest Fluke authorized service center to obtain return authorization information, then send the product to that service center, with a description of the difficulty, postage and insurance prepaid (FOB Destination). Fluke assumes no risk for damage in transit. Following warranty repair, the product will be returned to Buyer, transportation prepaid (FOB Destination). If Fluke determines that failure was caused by neglect, misuse, contamination, alteration, accident, or abnormal condition of operation or handling, including overvoltage failures caused by use outside the product's specified rating, or normal wear and tear of mechanical components, Fluke will provide an estimate of repair costs and obtain authorization before commencing the work. Following repair, the product will be returned to the Buyer transportation prepaid and the Buyer will be billed for the repair and return transportation charges (FOB Shipping Point).

THIS WARRANTY IS BUYER'S SOLE AND EXCLUSIVE REMEDY AND IS IN LIEU OF ALL OTHER WARRANTIES, EXPRESS OR IMPLIED, INCLUDING BUT NOT LIMITED TO ANY IMPLIED WARRANTY OF MERCHANTABILITY OR FITNESS FOR A PARTICULAR PURPOSE. FLUKE SHALL NOT BE LIABLE FOR ANY SPECIAL, INDIRECT, INCIDENTAL OR CONSEQUENTIAL DAMAGES OR LOSSES, INCLUDING LOSS OF DATA, ARISING FROM ANY CAUSE OR THEORY.

Since some countries or states do not allow limitation of the term of an implied warranty, or exclusion or limitation of incidental or consequential damages, the limitations and exclusions of this warranty may not apply to every buyer. If any provision of this Warranty is held invalid or unenforceable by a court or other decision-maker of competent jurisdiction, such holding will not affect the validity or enforceability of any other provision.

Fluke Corporation
P.O. Box 9090
Everett, WA 98206-9090
U.S.A.

11/99

Table of Contents

Title	Page
Introduction	1
Contact Fluke Corporation	1
Safety Information	2
Product Familiarization	2
Features	2
The Product	3
Primary and Secondary Triggers	4
Control Panel	5
Touch Screen (Display)	6
Menu Controls	6
Basic Operation	8
Turn On and Off the Product	8
Focus	8
Laser Pointer	9
Capture Image	9
Save Image	10
Save Images to PC	10
Main Menu	11
Measurement Menu	12
Level/Span	13
Emissivity Adjustment	14
Transmissivity	15
Image Menu	15
IR-Fusion™ Technology	16
Palette Menu	17
Select a Palette	18
Display Menu	19
Marker	19
Delta-T	20
Spot Box	20
Fluke Connect Menu	21
Asset Identification (Asset ID)	22
Assign Asset ID Tag with a QR Code or Barcode	22
Assign Asset ID Tag Manually	22
Exit an Asset ID Tag	22

Assign a Different Asset ID Tag	23
Fluke Connect Tools	23
Connection Icons.....	24
Save Images to Fluke Connect Cloud.....	25
Sign in to Fluke Connect WiFi Network.....	25
Sign out of Fluke Connect WiFi Network.....	26
Sign in to Fluke Connect Cloud.....	26
Sign out of Fluke Connect Cloud.....	26
Fluke Connect Wireless System.....	27
Pair Hotspot to Fluke Connect	27
Pair to Mobile App.....	27
Save Images to Shared Folder.....	28
Sign in to Shared Folder WiFi Network	28
Sign out of Shared Folder WiFi Network	29
Sign in to Shared Folder.....	29
Sign out of Shared Folder	30
Settings Menu.....	31
Capture Settings.....	33
Video	33
Record Video.....	33
View Video	34
Auto Capture	34
Bluetooth Headset.....	35
Date.....	35
Time	36
Image Annotation	36
Text Notes	36
Notes with Single Image.....	36
Add a Note to Multiple Images	37
Audio Notes.....	37
Record Audio Notes	37
Review Audio Notes	38
IR-PhotoNotes.....	38
Make IR-PhotoNotes.....	39
Review IR-PhotoNotes	39
Flag an Image	39
Manage Images.....	40
Delete an Image.....	40
Delete Multiple Images.....	40
Delete All Images	40
Memory Menu (Memory Gallery).....	41
View Image.....	42
Asset ID	42
Fluke Connect Desktop Software	42
Download Fluke Connect Software	43
Update Firmware.....	43
Accessories	43
Maintenance	44
Clean the Case.....	44

Lens Care	44
Battery Care	44
Charge Batteries.....	45
Two-Bay Battery Charger Base.....	45
AC Power Socket on Imager	45
Optional 12 V Vehicle Charger	46
Radio Frequency Data.....	46
Specifications	46

Introduction

The Fluke TiS55+/TiS75+ Thermal Imagers (the Product or Imager) are handheld, infrared imaging cameras for use in many applications. These applications include equipment troubleshooting, preventive and predictive maintenance, building diagnostics, and research and development.

The Imager displays thermal images on a high-visibility, industrial-quality LCD touch screen. The Imager can save images to internal memory or to a removable memory card. Saved images and data stored in internal memory or on the memory card can be transferred to a PC through a direct USB connection to the PC or by wireless transfer to a PC or mobile device.

The Imager works with the Fluke Connect™ app available on mobile devices and with the Fluke Connect software available for PCs.

A rugged, rechargeable lithium-ion smart battery provides power to the Imager. Direct ac power is accessible with the included ac power adapter.

Contact Fluke Corporation

Fluke Corporation operates worldwide. For local contact information, go to our website: www.fluke.com

To register your product, view, print, or download the latest manual or manual supplement, go to our website.

Fluke Corporation
P.O. Box 9090
Everett, WA 98206-9090

+1-425-446-5500

fluke-info@fluke.com

Safety Information

General Safety Information is in the printed Safety Information document that ships with the Product and at www.fluke.com. More specific safety information is listed where applicable.

A **Warning** identifies hazardous conditions and procedures that are dangerous to the user. A **Caution** identifies conditions and procedures that can cause damage to the Product or the equipment under test.

Product Familiarization

The manual explains features for multiple models. Because models have different features, not all of the information in the manual may apply to your Imager. Use [Table 1](#) to identify the features of your Imager.

Features

[Table 1](#) is a list of the features of the Imager.

Table 1. Features

Feature	TiS55+	TiS75+
Focus/Image Enhancement		
Advanced manual focus	●	●
EdgeSharp™ Technology	●	●
IR-Fusion™ Technology		
Full screen IR Autoblend™ (Preset percentage selection)	●	●
Visible Light Camera	●	●
Picture-in-Picture (PIP)	●	●
Image annotations		
IR-PhotoNotes™	●	●
Audio (Voice)	●	●
Text	●	●
Video mode		●
Auto capture mode	●	●
Markers	3	5
Spot Boxes	3	5
Dew point setting		●
Color Alarms	●	●

Table 1. Features (cont.)

Feature	TiS55+	TiS75+
Wireless connectivity		
WiFi™	●	●
Bluetooth®	●	●
Fluke Connect™ Connect to Fluke tools	●	●
Fluke Connect™/desktop software		
Stream video (radiometric streaming)		●

The Product

Table 2 shows the front of the Product.

Table 2. Front

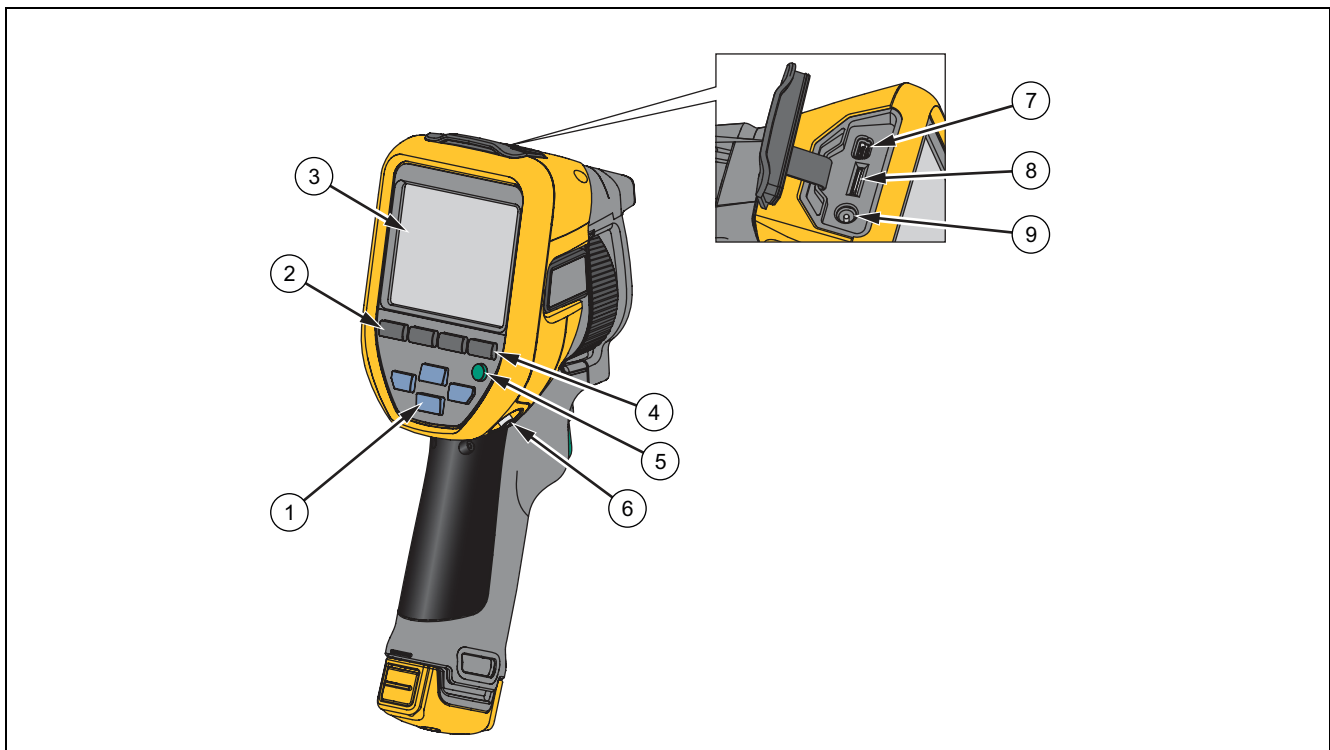

Item	Description	Item	Description
1	Control Panel Navigation buttons	6	Handstrap anchor
2	See Control Panel .	7	USB Cable
3	Touch screen	8	Memory Card slot
4	Memory button	9	Power input
5	Power button		

Table 3 shows the back of the Product.

Table 3. Back

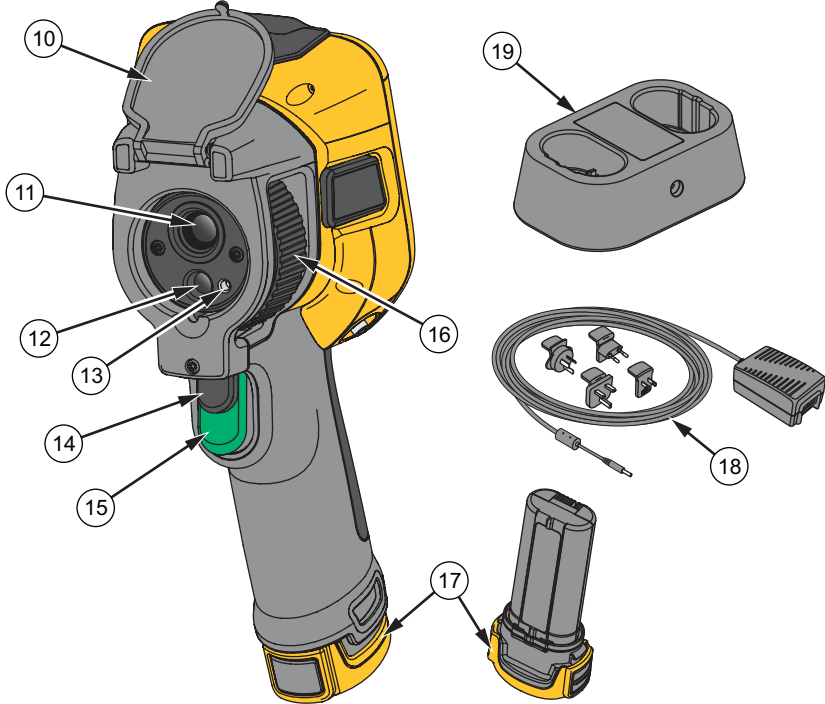

Item	Description	Item	Description
10	Retractable Lens Cover	15	Primary Trigger
11	Infrared Camera Lens	16	Manual Focus Control
12	Visual Light Camera Lens	17	Lithium-ion Smart Battery
13	Laser Pointer	18	AC Power Supply with Mains Adapters
14	Secondary Trigger	19	2-Bay Battery Charge Base (TiS75+only)

Primary and Secondary Triggers





The two-part trigger is located in the standard trigger position for a pistol-grip device. The larger, green trigger is the primary trigger. The smaller, black trigger is the secondary trigger.

Use the primary trigger to capture an image to save or edit. The default function of the secondary trigger is the laser pointer. From any menu, use the secondary trigger to return to camera mode. You can assign a specific function to the secondary trigger, see [Settings Menu](#).

Control Panel

The control panel is used to change parameters or select functions and options. [Table 4](#) lists the functions of the buttons on the Control Panel.

Table 4. Control Panel

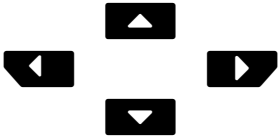
Button	Description
	Push to turn on or turn off the Product.
	Push to open the main menu. Within a submenu: Push to either save the change and go back to the previous menu. Or Push to perform the function listed on the submenu key.
	Push to open the main menu. Within a submenu: Push to either cancel the change and go back to the previous menu. Push to perform the function listed on the submenu key. Or Push and hold for 2 seconds to exit out of all menus.
	Push and hold for 2 seconds to toggle between Manual/Auto Level and Span. With Level/Span set to Manual , push to rescale the temperature values on the display at that time. See Level/Span .
	Push to review, edit, and delete captured images. See Memory Menu (Memory Gallery) .
	Push to move the cursor and highlight an option. With Level/Span set to Manual , push to adjust the Level and Span. See Level/Span . With Level/Span set to Auto , push to adjust the IR-Fusion level. In the Spot Box menu, push to adjust the size or position of the spot box. See Spot Box . In the Marker menu, push to move the marker. See Marker .

Touch Screen (Display)

The touch screen is the primary user interface of the Product. The touch screen has a backlight for work in dimly lit spaces.

Table 5 shows the default information on the screen of the Product.

Table 5. Display

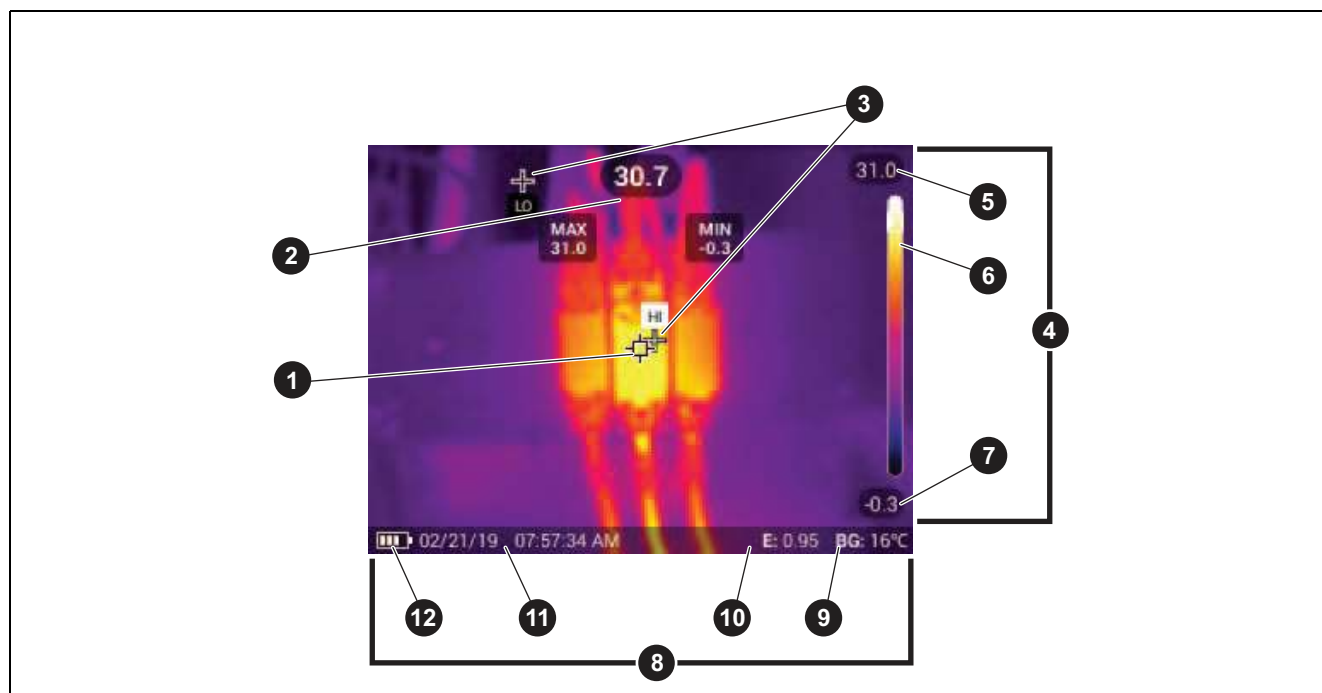

Item	Description	Item	Description
1	Center point marker	7	Temperature range lower value
2	Center point temperature	8	Status bar
3	High and low temperature markers	9	Background temperature
4	Scale	10	Emissivity value
5	Temperature range upper value	11	Date and time
6	Range bar The range of colors in the palette mapped to a certain range of temperatures	12	Battery status

Menu Controls

To use the menus to change and view settings:















1. Tap the display to open the main menu.
2. Tap an icon on the main menu to open a sub-menu. See Table 7.

The background of the selected icon changes to yellow.

3. Tap a menu control to set and change options. See [Table 6](#).
4. To close a sub-menu and return to live camera mode, tap the sub-menu icon again.

[Table 6](#) is a list of the menu controls.



Table 6. Menu Controls

Item	Control	Function
Slider bar		Adjusts a value. Touch and slide the bar to the left to decrease the value or to the right to increase the value.
Toggle switch		Turns on or off a feature.
Radio button		Selects one item from a list.
More menu options button		Opens a menu to show other menu options.
Option menu button		Opens an option menu to adjust a setting.
Numerical value adjuster buttons		Decreases a numerical value.
		Increases a numerical value.
Back arrow		Returns to the previous menu.
Exit button		Closes menu and returns to camera mode. Or, Exits out of an Asset ID. See Asset Identification (Asset ID) .
Delete button		Delete an image. See Manage Images .
Note button		View, add, or edit a note. See Text Notes .
Add a note button		With at least one note attached to an image, add another note to the image. See Text Notes .
Asset ID button		Add or remove an asset ID tag. See Asset Identification (Asset ID) .
Flag toggle switch		Toggle to add or remove a flag. See Flag an Image .

Basic Operation

Turn On and Off the Product

Before you use the Product for the first time, charge the battery. See [Charge Batteries](#).

To turn on the Product, push and hold  for 1 second. To turn off the Product, push and hold  for 2 seconds.

Note

All thermal Imagers need sufficient warm-up time for accurate temperature measurements and best image quality. Warm-up time can vary by model and environmental conditions. Although most Imagers are fully warmed up in 3 minutes to 5 minutes, wait a minimum of 10 minutes if the most accurate temperature measurement is important to your application. When you move an Imager between environments with large differences in ambient temperature, allow for additional adjustment time.

Focus

Correct focus makes sure that the infrared energy is correctly directed onto the pixels of the detector. Without correct focus, the thermal image can be blurry and the radiometric data may be inaccurate. Out-of-focus infrared images are frequently unusable or of little value.

To focus with the advanced manual focus system, rotate the Manual Focus Control until the inspection object is in proper focus.

To simulate fixed focus at 1.2 m, align the raised bar on the focus control with the marker on the case. See [Figure 1](#).

Figure 1. Fixed Focus

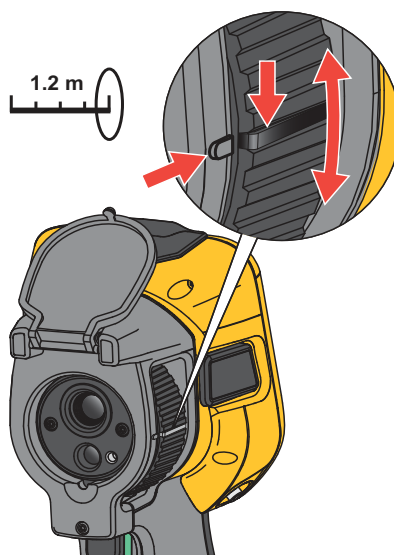

Laser Pointer

The Imager has a laser pointer. The laser pointer is a sighting aid and is offset from the infrared camera. As a result, it may not always represent the exact center of the infrared or visible image.

The laser dot does not appear on an infrared-only image, but does on visible-only or AutoBlend images. The laser dot cannot be seen in the visible channel of the IR-Fusion image if obscured by the center point marker graphic.

Pull the secondary trigger to turn on laser pointer, release the secondary trigger to turn off the laser pointer.

Capture Image

In normal operation (video is off), use the primary (green) trigger to capture a thermal image. The captured image goes into a memory buffer. You can view and annotate the image in the memory buffer before you store the image. When video is on, the primary trigger is the start/stop for video recording.

To capture an image:

1. Focus on a target.
2. Pull and release the **Primary Trigger** or double tap on the display to capture and freeze the image.

The image is in the memory buffer for you to save or edit the image.

Depending on the selected file format settings, the Imager shows the captured image and a menu bar. The menu bar shows the available options. You can add text or audio notes, create an IR-PhotoNote, or flag the image. To edit an image, see [Image Annotation](#).

Note

Asset ID tags, flags, and notes can be saved with images captured in .is2 file format only. To select .is2 file format, see [Settings Menu](#).

3. To assign an asset ID tag to the image, tap **Scan Asset ID**, or tap **Remove Asset ID** to remove an asset ID tag from the image. See [Asset Identification \(Asset ID\)](#).
4. Tap **Save**.

Save Image

To save an image as a data file:

1. Capture an image.

The image is in the memory buffer for you to save or edit the image.

2. Push **SELECT** to save the image as a file and go back to the live view. Alternatively, push the primary (green) trigger to save the image and go back to the live view.

The image is stored in the location selected in **Device Settings > Image Storage**.

Save Images to PC

To save images to a PC with the USB cord:

1. Turn on the Product.
2. Connect one end of the USB cord into the USB port on the Product and the other end into a USB port on a PC.

The PC recognizes the Product as an external memory storage device.

3. On the PC:
 - a. Browse to the directory on the Product.
 - b. Copy and paste or drag the images to a directory on the PC.
4. Remove the USB cord from the PC and the Product.

To save images to a PC from the memory card:

1. Remove the memory card from the Product, see [Table 2](#).
2. Insert the memory card into the memory card port on a PC.







The PC recognizes the card as a storage device.

3. On the PC:
 - a. Browse to the directory on the memory card.
 - b. Copy and paste or drag the images to a directory on the PC.
4. When you are finished, return the memory card to the Product.

Main Menu

Table 7 is a list of the secondary menus available in the Main Menu. From any menu, push the green trigger button to return to Camera mode.

Table 7. Main Menu

Secondary Menu		Function
	Measurement	Set the infrared settings. See Measurement Menu .
	Image	Adjust how the image appears. See Image Menu .
	Palette	Set the palette to use on the image. See Palette Menu .
	Display	Set the features to show on the display. See Display Menu .
	Fluke Connect	Save images over a WiFi connection. See Fluke Connect Menu . <i>Note</i> <i>The Fluke Connect system is not available in all countries.</i>
	Device Settings	Set user preferences and view information about the Product. See Settings Menu .

Measurement Menu

Table 8 is a list of the options available in the Measurement menu.

Table 8. Measurement Menu

Option Menu	Option	Description
Level/Span	Auto	Sets the Level/Span to adjust automatically or manually.
	Manual	
	Set Level/Span	With Level/Span set to Manual , changes the Level/Span. See Level/Span .
Emissivity	Custom Value	Sets a custom emissivity value when a value from the standard emissivity table is not appropriate for the measurement. See Emissivity Adjustment .
	<options>	Select an emissivity value from a list of common materials. Use the scroll bar to see all of the options. See Emissivity Adjustment .
Background	<options>	Changes the background temperature to compensate for reflected background temperature. Very hot objects or very cold objects can affect the apparent temperature and measurement accuracy of the target, especially when surface emissivity is low. Adjust the reflected background temperature to improve the accuracy of the measurement.
Transmissivity	<options>	Changes the values used to calculate the temperature based on the transmission percentage of the infrared-transparent window (IR window). See Transmissivity .

Level/Span

Level and Span are values within the total range of temperature. Level is the temperature level to view within the total range of temperatures. Span is the span of temperatures to view within the total range of temperatures. See [Table 9](#).

Table 9. Level and Span Settings

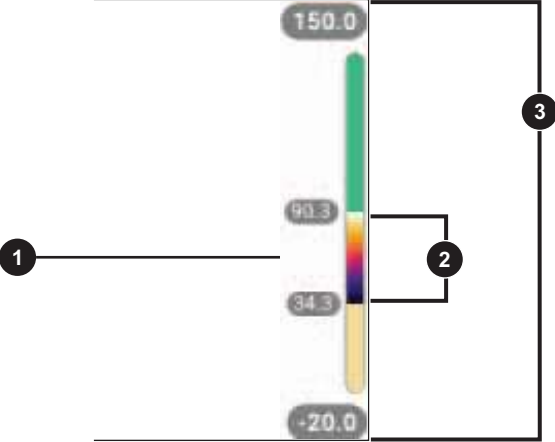







Item	Description
1	Level
2	Span
3	Total range

With Level/Span set to **Auto**, the Imager sets **Level/Span** based on the total temperature range.

With **Level/Span** set to **Manual**, the level setting moves the thermal span up or down within the total temperature range.

To change Level/Span:

1. Select  > **Level/Span** > **Manual**, or push  for 2 seconds.
2. Select **Set Level/Span**.
3. Push:
 -  to decrease the temperature span.
 -  to increase the temperature span.
 -  to move the span to a higher temperature level.
 -  to move the span to a lower temperature level.

The scale along the right side of the display shows the thermal span increasing or decreasing in size and shows the span as it moves to different levels within the total range. See [Table 9](#).

To use the temperature range high and low values on the display for future measurements:

1. Set Level/Span to **Manual**.
2. Push  to rescale the display and save the temperature values on the display at that time.

To use a different temperature range, use the arrow keys to change the Level/Span, or push  twice to rescale.

Note

The Imager always powers up in the same Level/Span mode, Auto or Manual, as when the Imager was powered down.

Emissivity Adjustment

All objects radiate infrared energy. The actual surface temperature and emissivity of the target affects the quantity of energy radiated. The Imager senses the infrared energy from the surface of the target and uses the data to calculate an estimated temperature value. Many common materials such as wood, water, skin, cloth, and painted surfaces, including metal, radiate energy well and have a high emissivity factor of $\geq 90\%$ (or 0.90). The Imager measures temperatures accurately on targets with a high emissivity.

Shiny surfaces or unpainted metals do not radiate energy well and have a low emissivity factor of < 0.60 . For the Imager to calculate a more accurate estimate of the actual temperature of targets with a low emissivity, adjust the emissivity setting.

Warning

To prevent personal injury, see emissivity information for actual temperatures. Reflective objects result in lower than actual temperature measurements. These objects pose a burn hazard.

Set emissivity as a direct value or from a list of emissivity values for some common materials. If the emissivity value is < 0.60 , a caution shows on the display.

Note

Surfaces with an emissivity of < 0.60 make it difficult to determine reliable and consistent actual temperatures. The lower the emissivity, the greater the potential of error when the Imager calculates the temperature measurement because more of the energy reaching the camera is specified as background temperature. This is also true even when adjustments to the emissivity and reflected background adjustments are performed properly.

Transmissivity

When you do infrared inspections through IR windows, not all of the infrared energy emitted from the target is transmitted through the optical material in the window. If you know the transmission percentage of the window, adjust the transmission percentage in the Imager or in Fluke Connect desktop software to improve the accuracy of the measurement.

When you do not do infrared inspections through an IR window, set Transmissivity to 100 % to disable the correction percentage.

Image Menu

Table 10 is a list of the options available in the Image menu.

Table 10. Image Menu

Option Menu	Option	Description
IR-Fusion	0 % to 100 %	The Imager automatically captures a visible image with every infrared image to show where a potential problem might be. See IR-Fusion™ Technology
Picture in Picture	On/Off	Shows the infrared image imposed on the visible light image to improve the picture context. Use with IR-Fusion to further improve the image.
EdgeSharp™	On/Off	Use EdgeSharp to digitally enhance an image with temperature overlays. EdgeSharp increases the visibility of actual features in an image.

IR-Fusion™ Technology

IR-Fusion™ technology makes it easier to understand, analyze, and communicate infrared images through the use of an aligned visible image and infrared image. The Imager automatically captures a visible image with every infrared image to show you precisely where a potential problem might be, and then allows you to more effectively communicate it to others.

Note

The visible image and infrared image can be customized or separated in SmartView and Fluke Connect Software when you use the .is2 or .is3 file format. See [Settings Menu](#).

The IR-Fusion slider bar sets the Product to take images from full visible light mode to full IR-Fusion mode. Use a blend between visible light mode and IR-Fusion to view an object with some temperature overlays.

To adjust the IR-Fusion level:

1. Tap .
2. Use the slider bar to set the IR-Fusion level.

Alternatively, you can adjust the IR-Fusion level in camera mode:

With Level/Span set to **Auto**, push  or  to change the IR-Fusion level.

Or,

Touch the display and slide left to right to increase the level of IR-Fusion. Slide from right to left to decrease the IR-Fusion level. See [Figure 2](#).

Figure 2. IR-Fusion Level

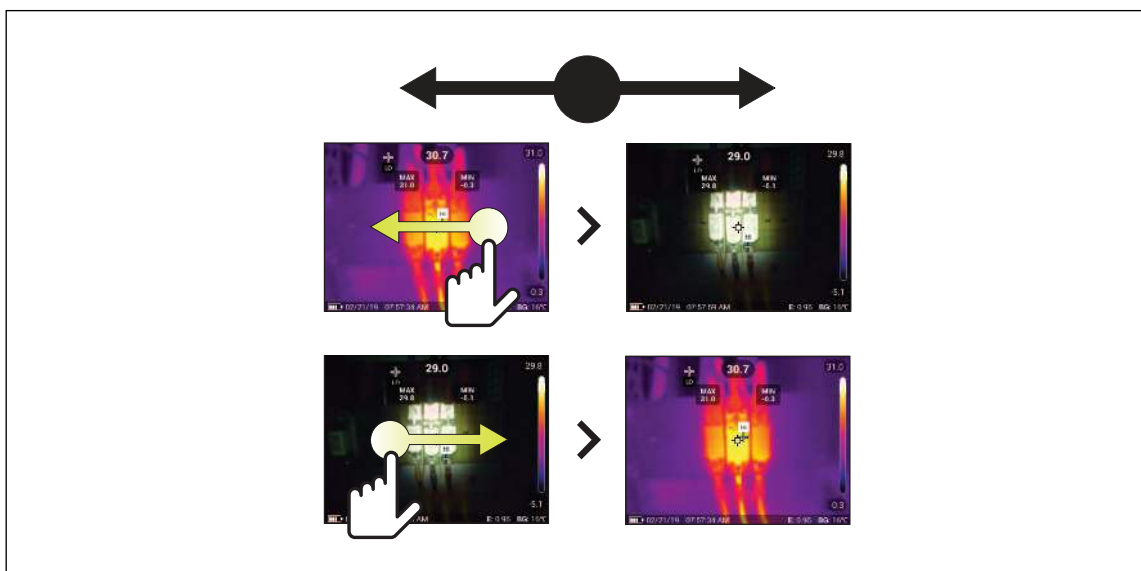

Palette Menu

Use the Palette menu to select the palette and set color alarms. The standard palettes offer an equal, linear presentation of colors that allow for best presentation of detail. [Table 11](#) is a list of the options in the Palette menu.

Table 11. Palette Menu

Option Menu	Option	Description
Palette	Grayscale Ironbow High Contrast Amber Hot Metal Blue-Red	Shows palette thumbnails. See Select a Palette .
Color Alarm	Off	Turn off color alarms
	High Alarm	Turn on the high-temperature color alarm. The high-temperature color alarm shows a full visible image and only shows infrared information on objects or areas that are above the set apparent temperature level. Use the arrows to adjust the temperature threshold.
	Low Alarm	Turn on the low-temperature color alarm. The low-temperature color alarm shows a full visible image and only shows infrared information on objects or areas that are below the set apparent temperature level. Use the arrows to adjust the temperature threshold.
	Inside Range	Turn on the inside range alarm. The inside range color alarm shows a full visible image and only shows color isotherms, or infrared information on objects or areas that are within the high and low temperature settings. Use the arrows to adjust the temperature high and low limits.
	Outside Range	Turn on the outside range alarm. The outside range color alarm shows a full visible image and only shows color isotherms, or infrared information on objects or areas that are outside the high and low temperature settings. Use the arrows to adjust the temperature high and low limits.
	Dew Point	(TiS75+ only) Show a full visible image and only show infrared information on objects or areas that are below the calculated dew point. Use the arrows to adjust the ambient temperature and the relative humidity.

Note

On the TiS55+, you can use the low-temperature color alarm function as a dew point color alarm. Determine and input the surface dew point temperature as the Low Alarm. The colors presented can help identify areas of concern with possible dew point condensation.

Select a Palette

To change the palette of an image:

1. Tap .
2. Tap on a palette thumbnail.
3. A check mark shows on the selected palette. The color and temperature range bar on the display changes according to the selected palette. See [Figure 3](#).

Figure 3. Palette and Range Bar Selection



Display Menu

Use the Display menu to set which features show on the display. To show the Fluke logo on the display, see [Settings Menu](#). [Table 12](#) lists the options in the Display menu.

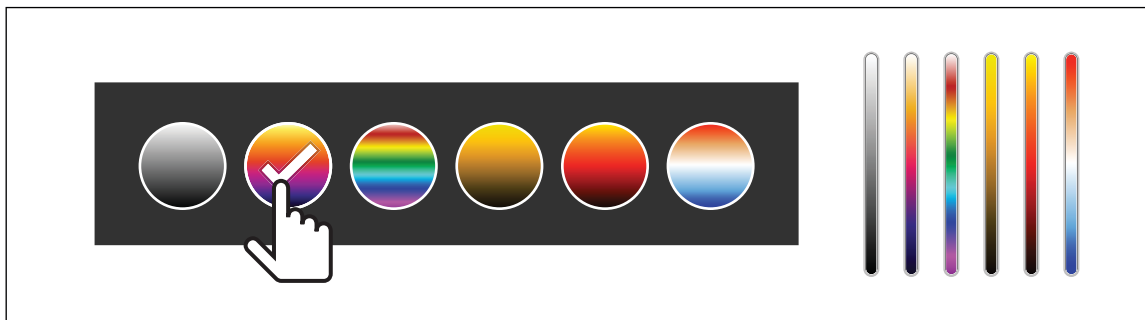



Table 12. Display Menu

Option	Description
Spot Temp (Min/Max)	Turn on or turn off the maximum and minimum temperature indicators on the display. The Spot Temperatures are floating HI and LO temperature indicators that move on the display as the temperature measurements of the image fluctuate.
Markers	Set the number of fixed-temperature spot markers. See Marker . Sets a temperature reference mark. See Delta-T .
Spot Boxes	Set the number of temperature measurement zones (boxes) that centers on a target. See Spot Box .
Center Point	Turn on or turn off the Center point marker and Center point temperature.
Scale	Turn on or turn off the Scale.
Status Bar	Turn on or turn off the Status bar.

Marker

Use a fixed-temperature spot marker to show the temperature at the point before you save an image.

To set a marker:

1. Select  > **Markers**.
2. Select the number of markers.
The marker symbol (+) shows on the display.
3. Drag the marker or push  /  /  /  to move the marker on the image.
4. Push **SELECT** to set the change and go to the next marker.
5. Continue to set markers. On the final marker push **SELECT** to exit.
On the camera screen you can tap and drag markers at any time.

Delta-T

Use Delta-T to set the center point or a spot marker to use as a temperature reference mark. The other markers will show the temperature difference from the reference point. At least one marker must be on to use the Delta-T feature.

To set a temperature reference mark:

1. Select  > **Markers** > **Delta-T**.
2. Select the marker to use as the reference, or select the Center Point.
 - The temperature shows next to the reference mark
 - △ The temperature difference relative to the temperature of the reference mark shows next to the other spot markers.

Note



If you only have one marker, the reference marker is the Center Point. The Center Point can be a temperature reference mark, but it cannot be the delta point. It is either the main reference mark or it is not a delta reference at all.

Spot Box

Use the Spot Box feature to set a temperature measurement zone (box) to center on the target and to adjust the sizes or position of the box. The box expands or contracts to different levels within the infrared image. The box shows an approximate maximum (MAX), average (AVG), and minimum (MIN) temperature measurement in that area.

To set a spot box:

1. Select  > **Spot Boxes**.
2. Select the number of Spot Boxes.



A white box shows on the display.  toggles between **Size** and **Position**.
3. If necessary, push  to select **Size**.











 shows on the display.

4. Drag  to increase or decrease the size of the Spot Box.

Or,

Push:

-  to decrease the vertical size.
-  to increase the vertical size.

-  to decrease the horizontal size.
 -  to increase the horizontal size.
5. Push  to select **Position**.
 shows on the display.
 6. To move the box, drag the center of the box or push  /  /  / .
 7. Push  to set the change and go to the next Spot Box.
 8. Continue to set Spot Boxes. On the final box push  to exit.

Fluke Connect Menu

Table 13 lists the options in the Fluke Connect menu.

Table 13. Fluke Connect Menu

Option Menu	Option	Description
Scan Asset ID	NA	Assign images to an asset. Scan a QR code or barcode attached to an asset or manually enter an asset identification. See Asset Identification (Asset ID) .
	WiFi	Turn on or turn off WiFi.
Save Images to Fluke Connect Cloud	WiFi Network	With WiFi enabled, connect the Product to a WiFi network so you can sign in to your Fluke Connect account.
	Sign in to	
	Pair to Fluke Connect Tools	On/Off
Pair Hotspot to Fluke Connect	WiFi Hotspot	Uses the Product to create a wireless Hotspot when no WiFi network exists. See Fluke Connect Wireless System .
	WiFi Hotspot Settings	
Save Images to Shared Folder	WiFi	Turn on or turn off WiFi.
	WiFi Network	With WiFi enabled, connect the Product to a WiFi network so you can sign in to a shared folder on a network. See Save Images to Shared Folder .
	Shared Folder	

Asset Identification (Asset ID)

Use Asset ID to save and organize images by asset like a motor or electrical panel. Use a barcode, QR code, or other unique identification as a tag to attach to images. When in camera mode, the asset ID shows on the display and looks like . Make Asset IDs unique to each asset.

Assign Asset ID Tag with a QR Code or Barcode

To save images to an asset with a QR code or barcode:

1. Select  > **Scan Asset ID**.
2. Focus a QR code or barcode in the white box on the display.
3. When the Product detects and scans a barcode, tap **Use Barcode** or **Use QR Code**. If the Product cannot detect a barcode or QR code, manually enter a unique asset ID. See [Assign Asset ID Tag Manually](#).

The display returns to camera mode, and the barcode or QR code number shows on the display.

4. Capture an image.

Assign Asset ID Tag Manually

To manually enter a unique asset ID:

1. Select  > **Scan Asset ID**.
2. Tap **Manual Entry**.
A keyboard opens on the display.
3. Enter a unique asset identification.
4. Tap **Save**.

The display returns to camera mode, and the asset ID shows on the display.

Exit an Asset ID Tag



To exit out of an asset ID and save images without an asset ID:

1. Tap the asset ID that looks like  on the display.
2. Tap  **Exit Asset ID xxxxx** (where xxxxx is the name of the asset ID).

The display returns to camera mode, and the asset ID does not show on the display.

Assign a Different Asset ID Tag

To exit out of an asset ID and save images with a different asset ID:

3. Tap the asset ID that looks like  on the display.
4. Tap  **Scan New Asset ID**.
5. Assign a new asset ID. See [Asset Identification \(Asset ID\)](#).

Fluke Connect Tools

Use the Imager to wirelessly connect to Fluke Connect-supported tools to:

- View the live measurement of each tool.
- Capture the measurement of each tool in .is2 and .is3 images.

To discover a Fluke Connect-supported tool:

1. Turn on each wireless tool and make sure the wireless feature is enabled. See the documentation of each tool for more information about how to use the tool.
2. Turn on the Imager.
3. Select  > **Pair to Fluke Connect Tools**.
4. Select **On**.

The Imager starts to scan and presents a list with the ID and name of available tools found within 20 m without obstructions (open air) or within 6.5 m with obstructions (sheetrock wall). You can expect a short delay before the scan is complete.

The Fluke Connect button on each wireless tool will flash.

5. On the Imager, select the tool name.
6. For each tool, tap the tool or push **SELECT** to select the tool.

The Imager shows the tool in the My Tools list as connected. The tool shows with the current reading.

The Fluke Tool shows an ID (Identification) number for reference to the list on the Imager.

7. Push **SELECT** to return to the Camera mode.

The readings from the tool show on the display. Tap the tool readings on the Imager to return to the Pair Fluke Connect Tools menu.

To disconnect from a connected tool:

1. On the Imager, tap the tool.
2. Tap **Forget**.

The tool shows on the Available Tools list. The tools on the My Tools list will re-order, if necessary.

3. Select **On**.

To disconnect all tools, restart the camera.

If the tool goes out of range, the tool shows no reading. On the My Tools list, the tool shows as not connected. Tap the tool to acknowledge (**OK**) or remove the tool (**Forget Tool**).

Connection Icons

Icons show the status of the Product connection. [Table 14](#) explains the icons.

Table 14. Connection Icons











Icon	Description
No icon	WiFi is not on.
	In a menu, the Product is attempting to connect to a WiFi network.
	The Product is connected to a WiFi network.
	WiFi is on, but the Product is not connected to a WiFi network.
	In a menu, shows beside the network name that the Product is connected to.
	WiFi is on, and the Product is attempting to connect to a Fluke Connect account. Or, Images are saving to a Fluke Connect account.
	WiFi is on, and the Product is connected to a Fluke Connect account.
	The Product is not connected to a Fluke Connect account.
	WiFi is on, and the Product is attempting to connect to a shared folder on a network server. Or, Images are saving to a shared folder.

Table 14. Connection Icons (cont.)

Icon	Description
	WiFi is on, and the Product is connected to a shared folder on a network server.
	The Product is not connected to a shared folder on a network server.

Save Images to Fluke Connect Cloud

When the Product is connected to a WiFi network, you can sign into your Fluke Connect account on the Product and use Fluke Connect Instant Upload. When you use Fluke Connect Instant Upload, the images you take with the Product automatically upload to your Fluke Connect account in the Fluke Cloud. You can view the images saved in the Fluke Cloud on the Fluke Connect website without the mobile device and Product connected to each other.

Note

The Instant Upload feature may not work on all networks or with all devices due to the security profiles on different networks.

Sign in to Fluke Connect WiFi Network

Use the WiFi Network setting to connect the Product to a WiFi network and to sign into a Fluke Connect account on the Product.

To turn on the WiFi Network feature:



1. Select  > **Save Images to Fluke Connect Cloud** > **WiFi** > **On**.
2. Push **WiFi Network** to scan for available networks within range of the Product.
3. Tap on a network to connect to it.
4. If you are prompted to enter a user name and password:
 - a. Use the keyboard to enter a new user name, or tap ▼ to see a list of recently used user names.
 - b. Tap **Next**.
 - c. Use the keyboard to enter a password.
 - d. Tap **Sign In**.
 - e. Tap **OK**.

The display returns to the Save to Fluke Connect menu.

5. Sign in to Fluke Connect. See [Sign in to Fluke Connect Cloud](#).

Sign out of Fluke Connect WiFi Network

To sign out of a WiFi network:

1. Select  > **Save Images to Fluke Connect Cloud** > **WiFi Network**.
2. Tap the name of the connected network.
3. Tap **Forget Network**.
4. Tap  to return to camera mode.

Sign in to Fluke Connect Cloud

To sign in to your Fluke Connect account:

1. Turn WiFi on and connect to a WiFi network. See [Sign in to Fluke Connect WiFi Network](#).
2. Tap **Sign in to Fluke Connect**.
3. Use the keyboard to enter an email address, or tap ▼ to see a list of recently used email addresses.
4. Tap **Next**.
5. Use the keyboard to enter a password.
6. Tap **Sign In**.
7. Tap **OK** to return to camera mode to capture images.

Sign out of Fluke Connect Cloud

To sign out:

1. Select  > **Save Images to Fluke Connect Cloud** > **Sign in to Fluke Connect**.
2. Tap **Sign Out**.

The display returns to the Save to Fluke Connect menu.

3. Tap .

Fluke Connect Wireless System

The Product supports the Fluke Connect Wireless System. The Fluke Connect system wirelessly connects your Fluke test tools with an app on a mobile device. It shows images from the Product on your mobile device.

Note

The Fluke Connect system is not available in all countries.

Pair Hotspot to Fluke Connect

Use the Product to create a wireless Hotspot when no WiFi network exists. You can use the Hotspot to download saved pictures or stream live images from the Product to a mobile device with the Fluke Connect app.

Note

WiFi is for indoor use only in Kuwait, Chile, and United Arab Emirates.

To create a Hotspot, pair the Product to the Fluke Connect app. See [Pair to Mobile App](#).

To change the hotspot settings:

1. Select  > **Pair Hotspot to Fluke Connect** > **WiFi Hotspot Settings**.
2. Select an option:
 - **Name (SSID)** to change the SSID
 - **Password** to turn on or turn off the password or to change the password
 - **Channel** to change the channel
3. Use the keyboard to enter the information for the option.
4. Tap **Save** to use the Product.

Pair to Mobile App

The Fluke Connect app works with Apple and Android products. The app is available for download from the Apple App Store and Google Play.

The Fluke Connect app will be available after initial release. When the app becomes available, you can download the app from the Apple App Store and Google Play.

To use the Fluke Connect app with the Product:

1. On the Product, select  > **Pair Hotspot to Fluke Connect** > **WiFi Hotspot** > **On**.
2. On the mobile device:

- a. Go to **Settings > Wi-Fi**.
- b. Select the Wi-Fi network that begins with **Fluke...**
3. On the Fluke Connect app, select **Thermal Imager** from the list.

The pictures you take with the Product are saved on your mobile device and on the Product.

Note

To save images to the Fluke Connect app, set the file format to .is2 (see [Settings Menu](#)).

4. On the Product:
 - a. Capture an image.

The image is now in the memory buffer.
 - b. Tap **Save** to save the image and view the image on the phone app.

Go to www.flukeconnect.com for more information about how to use the app.

Save Images to Shared Folder

When the Product is connected to a WiFi network, you can select a folder on a server. The images you take with the Product save to the Product and automatically upload to the selected folder on the server. Anyone with access to the folder on the server can view the images immediately.

Note

The Shared Folder feature may not work on all networks or with all devices due to the security profiles on different networks.

Sign in to Shared Folder WiFi Network

Use the WiFi Network setting to connect the Product to a WiFi network and to sign into a Fluke Connect account on the Product.

To turn on the WiFi Network feature:

1. Select  > **Save Images to Shared Folder > WiFi > On**.
2. Tap **WiFi Network** to scan for available networks within range of the Product.
3. Tap on a network to connect to it.
4. If you are prompted to enter a user name and password:
 - a. Use the keyboard to enter a new user name, or tap ▼ to see a list of recently used user names.



- b. Tap **Next**.
- c. Use the keyboard to enter a password.
- d. Tap **Sign In**.
- e. Tap **OK**.

The display returns to the Save to Fluke Connect menu.

5. Sign in to a shared folder. See [Sign in to Shared Folder](#).

Sign out of Shared Folder WiFi Network

To sign out:

1. Select  > **Save Images to Shared Folder > WiFi Network**.
2. Tap the name of the connected network.
3. Tap **Forget Network**.
4. Tap  to return to camera mode.

Sign in to Shared Folder

Note

To learn how to create or access a shared folder on a network, contact your IT department.

To use the Product to sign in to a shared folder on a network:

1. Turn WiFi on and connect to a WiFi network. See [Sign out of Shared Folder WiFi Network](#).
2. Tap **Shared Folder > File Path**.
3. Use the keyboard to enter a file path, or tap ▼ to see a list of recently used file paths. After you enter a file path for the first time, the field automatically shows the last used file path.

4. Tap **Save**.

Depending on your security environment, enter a username and password:

- a. Tap **Username and Password**.
 - b. Use the keyboard to enter a new user name, or tap ▼ to see a list of recently used user names.
 - c. Tap **Next**.
 - d. Use the keyboard to enter a password.
 - e. Tap **Next**.
 - f. Tap **Sign In**.
5. Tap **Connect**.
6. Tap **OK**.

If images in the Product memory have not been saved to a shared folder, a message prompts you to save the images.

- Tap **Save Images** to save images to the shared folder.



Or,

- Tap **Not Now** to save the images to the shared folder another time.

The display returns to the Save to Shared Folder menu.

7. Tap  to return to camera mode to capture images.

Note

Keep the Product on and stay in the range of the WiFi network until images are uploaded. If the connection is lost before all the images are saved to the shared folder,  shows on the title bar of the Memory menu. Sign in to the shared folder again and tap  to upload the images.

Sign out of Shared Folder

To sign out:

1. Select  > **Save Images to Shared Folder** > **Shared Folder** > **Disconnect**.

The display returns to the Save to Shared Folder menu.

2. Tap  to return to camera mode.

Settings Menu

Table 15 is a list of the options in the Settings menu.

Table 15. Settings Menu

Option Menu	Option	Description
Capture Settings	Video	See Capture Settings .
	Auto Capture	See Auto Capture .
	Bluetooth Headset	See Bluetooth Headset .
	Data Streaming	Turn on Data Streaming to connect to PC software.
Backlight	NA	Slider to adjust the backlight
File Format	IS2	Saves images as a .is2 file. Choose the .is2 file format when image modification and maximum resolution is needed. The .is2 file format consolidates the infrared image, radiometric temperature data, visible image, voice annotation, and photos from the IR-PhotoNotes photo annotation system into a single file. To customize or separate the visible and infrared images, use SmartView software or the Fluke Connect app.
	JPEG	Saves images as a .jpg file. Choose the .jpg file format for images with the smallest file size, where modification is not needed, and image quality and resolution are not as important.
	Visible Light Camera Resolution	Sets the megapixels (MP) on the visual light camera. (5.0 Megapixel or 1.3 Megapixel)
Units	<options>	Sets the temperature units to Celsius or Fahrenheit. This option is not available in all countries.
Distance	Units	Sets the units to use to measure distance. This option is not available in all countries.

Table 15. Settings Menu (cont.)

Option Menu	Option	Description
Auto Off	LCD Time Out	Set the time before the display automatically turns off.
	Power Off	Set the time before the Imager automatically turns off. <i>Note</i> <i>Auto Off is automatically disabled when the battery is connected to ac power.</i>
Date	<options>	Set the date format and the date. See Date .
Time	<options>	Set the time format and the time. See Time .
Image Storage	Internal Memory SD Card	Set the location to save images.
Secondary Trigger	Laser	(default) Set the function of the secondary (black) trigger to the laser function. The laser is active only while pushing the trigger.
	Scan Asset ID	Set the function of the secondary (black) trigger to the QR code reader function. (Scan Asset ID) Use the QR code reader for Asset Tagging.
Logo	NA	Show or hide the Fluke logo on the display.
Language	<options>	Set the language to use on the display.
Decimal Separator	<options>	Set the decimal separator to comma or decimal point.
Localization	<options>	Set the decimal separator to comma or decimal point.
Change Filename	NA	Change the default filename that starts with IR_ to a different 3-character prefix with the touch screen keyboard.
Reset to Factory Defaults	NA	Erase all user-set preferences and restores the factory default settings. This does not erase images in memory.
Certificates	NA	Show information about the wireless certificates of the Product.
Licenses	NA	View information about the version, certificates, and Open Source Software Licenses of the Imager.
Version	NA	Firmware version of the camera.

Capture Settings

Video

You can record video with and without audio. See [Table 16](#). The thermal scene and complexity of the recorded data affects the amount of time available to record a video.

Table 16. Video

Option		Description
Record Video Only		Start a video recording when the primary trigger is pressed. See Record Video .
Record Video/Audio		Requires a Bluetooth headset. Starts a video recording with audio. See Record Video .
Video File Fomat	IS3	Save videos as an .is3 file with radiometric video capture. Choose the .is3 video format when video modification and maximum resolution is needed. To edit the .is3 video file, use SmartView software or the Fluke Connect app.
	AVI	Save videos as an .avi file with .mpeg encoding. Choose the .avi video format when video modification is not required. The file retains the video settings at the time the video was captured and saved.

Record Video



To quickly record a video, push and hold the primary trigger for 2 seconds. Release the button once the recording starts.

To record:

1. Select  > **Capture Settings** > **Record Video only** OR **Record Video/Audio**.
2. Push the primary trigger.
3. The Imager starts the recording.
4. To pause the recording, push the primary trigger.
5. To restart the recording, push the primary trigger again.
6. To save the video, push **SELECT**.
7. To delete the video, push **BACK** and then tap **Delete**.

View Video

To play a video:

1. Push .
2. Select a file to play. All video files show as a thumbnail.
3. Tap the play button.
4. To pause or restart push .
5. To delete, push  and tap the delete icon and then tap **Delete** to confirm.

Auto Capture

Use Auto Capture to set parameters so the camera will automatically take images.

To configure **Auto Capture**:

1. Select  > **Capture Settings** > **Auto Capture**.
2. Choose the capture frequency.
 - To capture images at a specified interval, select **Interval**. Use the arrows to set the interval time.
 - To capture a set number of images, select **Image Count** > **Number of Images**. Use the arrows to select the number of images. The default number is 5.
 - To capture images until the memory is full, select **Image Count** > **Maximum Memory**.
 - Choose the trigger that will start the automatic **image capture**.
 - To automatically capture images based on temperature, select **Temp Trigger**. Select whether the trigger will be Over or Under the specified temperature. Use the arrows to set the specified temperature. Select which reference point where the temperature will be monitored.
 - To start the Auto Capture manually, select Manual Trigger.

Start manual trigger Auto Capture:

1. Select  > **Capture Settings** > **Start Capture**.

 appears on the display.

2. Push the primary trigger.

3. The Imager will take images as configured.

Start temperature trigger Auto Capture:

1. Position the camera and set the markers and spot boxes as required.
2. Select  > **Capture Settings** > **Start Capture**.

 appears on the display.

The Imager will take images when the temperature of the marker, center point, or spot box reaches the trigger condition.

Bluetooth Headset

Connect a Bluetooth Headset to support audio features.

To connect a Bluetooth Headset:

1. Put the Bluetooth Headset into pairing mode.
2. On the Imager, select  > **Bluetooth Headset** > **On**.

The Imager starts to scan and presents a list with of available devices. You can expect a short delay before the scan is complete.





Tap the headset to select it.

The headset will connect and show on the My Devices list. A headset icon displays in Camera mode.

Date

The date shows as: **MM/DD/YY** or **DD/MM/YY**.

To set the date:

1. Select  > **Date**.
2. Select **MM/DD/YY** or **DD/MM/YY**.
3. Push **SELECT** to set the new format.
4. Select **Set Date**.
5. Push **SELECT** to open the Set Date menu.
6. Push  /  to select **Day**, **Month**, or **Year**.
7. Push  /  to change the day, month, or year.
8. Push **SELECT** to set the date and exit the menu.

Time

Time shows as: **24 hour** or **12 hour**.

To set the time format:







1. Select  > **Time**.
2. Select **24 hour** or **12 hour**.
3. Push **SELECT** to set the time format.
4. Select **Set Time**.
5. Push **SELECT** to open the Set Time menu.
6. Push  /  to select **Hours** or **Minutes**.
7. If you selected the 12 hour format, select **AM** or **PM**.

Image Annotation

You can annotate images with text and audio. See [Table 17](#).

Table 17. Annotations

Icon	Option	Description
	Text Note	Add text notes. See Text Notes .
	Audio Note	Add audio notes. See Audio Notes .
	IRPhotoNotes	Add photo images from the visible light camera. See IR-PhotoNotes .
	Flag Image	Mark an image for review. See Flag an Image .

Text Notes

Notes are stored with the image so you do not need to collate multiple files later. To add, edit, and delete notes, use the keyboard that opens on the display.

Images that have text notes show with the note icon ().

Notes with Single Image

Choose a method to add, edit, or delete a note for an image:

- For an image in the memory buffer: Select **Edit > Text Note**.
- For a saved image: Open the image in fullscreen mode.

1. Tap . If needed, tap  first.

If no notes are saved with the image, a keyboard opens on the display.

2. Use the keyboard to enter a message.
3. Tap **Save**.
If a note is saved with the image, a list of notes opens on the display.
4. To add another note to the image, tap , use the keyboard to add the new note, and tap **Save**.
5. To edit a note, tap on a note, use the keyboard to edit it, and tap **Save**. If needed, scroll down to see all the notes.
6. To delete a note, tap on a note, tap **Delete**, and tap **Delete** again.

Add a Note to Multiple Images

To add a note to multiple images at the same time:

1. Select **MEMORY** >  > **Add a Note to Multiple Images**.
The display returns to the memory gallery.
2. Tap an image to select it. Tap an image again to clear the selection.
The border and filename text color change to yellow.
3. Repeat for each additional image.
4. Tap **Add Note**.
A keyboard opens on the display.
5. Use the keyboard to enter a message.
6. Tap **Save**.

Audio Notes

Audio notes require an .is2 image and a Bluetooth headset.

Images that have audio notes show with the audio icon ().

Record Audio Notes

Choose a method to add, edit, or delete a note for an image:

- For an image in the memory buffer: Select **Edit** > **Audio Note**.
 - For a saved image: Select **MEMORY** > image > ... > **Audio Note**.
1. Tap **Record** and begin recording.
You can record up to 60 seconds of audio.
To cancel, tap **Cancel**.

2. To pause, tap **Pause**.

You can save or playback while the recording is paused.

- To save, tap **Save**. The recording is saved.
- To playback, tap **Play**. You can tap **Pause** to pause the playback or **Record** to resume recording.

3. To save the recording tap **Pause** and then tap **Save**.

The Audio note is saved. The menu shows the number of seconds of the Audio note.

Review Audio Notes

You can review the audio note from the memory buffer.

1. Select **Edit > Audio Note**.
2. To listen to the recording, tap **Play**.
3. To record additional audio, tap **Append**.
4. To delete the audio note, tap **Delete**.

You can save or playback while the recording is paused.

- To save, tap **Save**. The recording is saved.
- To playback, tap **Play**. You can tap **Pause** to pause the playback or **Record** to resume recording.

IR-PhotoNotes

Use the IR-PhotoNotes photo annotation system to capture visible images of various objects, text, or other information that is related to the analysis and reporting of an infrared image. A visible image is a clear digital photo and does not use infrared technology. Examples of possible annotations include motor name plates, printed information or warning signs, larger views of the environment or room, and related equipment or objects. IR-PhotoNotes images are only available in the .is2 file format and are stored in the file so you do not need to collate multiple files at a later time.

Images that have IR-PhotoNotes show with the icon ()

Make IR-PhotoNotes

Choose a method to add, edit, or delete a note for an image:

- For an image in the memory buffer: Select **Edit > IRPhotoNotes**.
- For a saved image: Select **MEMORY** > image > ... > **IRPhotoNotes**.

The Imager opens the Visible Light Camera so you can take an image.

1. For each image to save, push the primary trigger to take an image.

Note

The TiS55+ can take one IR-PhotoNote only.

2. To stop taking images and return to the menu, tap **Done**.

The images are saved and the menu shows the number of images.

Review IR-PhotoNotes

For an image in the memory buffer:

1. Select **Edit > IRPhotoNotes**.

The Imager opens the images.

2. Tap an image to select the image (TiS75+).



3. To delete an image, tap the trash icon , and then tap **Delete**.

The images are saved and the menu shows the number of images.

4. To take another image, tap the add icon , and then press the primary trigger to take the photo.

Flag an Image

Flag an image to review later. The flag feature is a toggle switch.

To flag an image, open an image in full screen mode, and tap . The flag icon changes to . Tap again to remove the flag.

Manage Images

You can delete images from Memory or during review.

Delete an Image

To delete only one image:

1. Open an image in full-screen mode.
2. Tap .
3. Tap **Delete**.

Delete Multiple Images

To delete multiple images at the same time:

1. Select **MEMORY** >  > **Delete Multiple Images**.

The display returns to the memory gallery.

2. Tap an image to select it. Tap an image again to clear the selection.
The border and filename text color change to yellow.
3. Repeat for each additional image.
4. Tap **Delete Images**.
5. Tap **Delete**.

Delete All Images

To delete all of the images at the same time:

1. Select **MEMORY** >  > **Delete All Images**.
2. Tap **Delete**.

Memory Menu (Memory Gallery)









Note

When the memory is 90 % full, a yellow message bar shows at the top of the display. When the memory is full, the message bar changes to red. To capture more images when the internal memory is full, save the images to an external memory device and delete the images from the Product.

Images are saved to the internal memory storage. Use the Memory menu to view, edit, or delete images. Images are organized by the date they were captured with the newest images at the top.

When additional information has been saved with an .is2 file, an icon shows with the preview file. [Table 18](#) shows the icons.

Table 18. Image Icons

Icon	Description
	Asset ID
	Text Note
	Audio Note
	IR-PhotoNote
	Asset flag
	Image is saving to a shared folder
	Image saved to a shared folder
	Image is not saved. Return to WiFi range to save.

View Image

To open an image in fullscreen mode:

1. Push .
2. If needed, touch the display and slide up or down to view all the images.
3. Tap on a thumbnail or preview image to view the image fullscreen.

A toolbar briefly opens on the top of the display. Tap on the image to open or close the toolbar.

Asset ID

Use the image toolbar to add or remove an asset ID from an image that is saved in memory. See [Asset Identification \(Asset ID\)](#).

To add an asset ID to an image:

1. Open an image in fullscreen mode.
2. Tap .
3. Assign an asset ID. See [Asset Identification \(Asset ID\)](#).

To remove an asset ID from an image:

1. Open an image in fullscreen mode.
2. Tap the asset ID that looks like  on the display.
3. Tap **Remove**.

The display returns to the image in fullscreen mode, and the asset ID does not show on the display.

Fluke Connect Desktop Software

Fluke Connect desktop software for a PC is available to use with the Product and contains features to analyze images, organize data and information, and make professional reports.

Use Fluke Connect software to:

- Review notes, asset IDs, and flags.
- Export IR and visible images.
- Edit .is2 image files.
- Update the firmware with new features.

Download Fluke Connect Software

To download Fluke Connect desktop software:

1. Go to <https://www.fluke.com/en-us/support/software-downloads/software-for-fluke-infrared-cameras>.
2. On the website, follow the instructions to download the software to the PC.
3. On the PC, follow the instructions to install Fluke Connect software.
4. Administrator privileges are required for the installation.
5. Restart the PC when installation is complete.

Update Firmware

To update the firmware:

1. On the PC, open Fluke Connect software.
2. Connect one end of the USB cord into your PC and the other end of the USB cord into the Product.

Fluke Connect software recognizes the connection with the Product. Windows automatically installs the device driver for use with the Product.

3. On the PC:
 - a. Select **Yes** if prompted to download a firmware update file onto the PC.
 - b. Select the Product from the list on the left.
 - c. Select **Yes** if prompted to download a firmware update to the Product.
4. On the Product, Tap **Ok**.

To complete the firmware update, the Product turns off.

5. To use the new firmware, turn on the Product.

Accessories

See www.fluke.com for a list of accessories available for the Product.

Maintenance

The Product requires minimum maintenance.

Clean the Case

Clean the case with a damp cloth and a weak soap solution. Do not use abrasives, isopropyl alcohol, or solvents to clean the case.

Lens Care

Caution

To prevent damage to the infrared lens:

- **Carefully clean the infrared lens. The lens has a delicate anti-reflective coating.**
- **Do not clean the lens too vigorously because this can damage the anti-reflective coating.**

To clean the lens:

1. Use a pressurized can of air or a dry nitrogen-ion gun, if available, to blow off the particulates from the lens surface.
2. Soak a lint-free cloth in a commercial lens cleaning liquid that contains alcohol, ethyl alcohol, or isopropyl alcohol.
3. Squeeze the cloth to remove excess liquid.
4. Wipe the lens surface in one circular motion and discard the cloth.
5. If needed, repeat with a new lint-free cloth.

Battery Care

To get the best performance from the lithium-ion battery:

- Do not charge the Product for more than 24 hours as reduced battery life may result.
- Charge the Product for at least 2.5 hours every six-months for maximum battery life. Without use, the battery will self-discharge in approximately six months.

Charge Batteries

Caution

To prevent damage to the Imager:

- Do not store the batteries in extreme cold environments.
- Do not attempt to charge the batteries in extreme cold environments.

Caution

Do not incinerate the Product and/or battery.

Before you use the Imager for the first time, charge the battery for at least 2.5 hours. The battery status shows on the five-segment charge indicator.

Note

New batteries are not fully charged. Two to ten charge/discharge cycles are necessary before the battery charges to its maximum capacity.

To charge the battery, use one of the options that follow.

Two-Bay Battery Charger Base

To charge the battery in the charger base:

1. Connect the ac power supply to the ac wall outlet and connect the dc output to the charger base.
2. Put one or two smart batteries into bays of charger base.
3. Charge batteries until charge LEDs on charger base are a solid green.
4. Remove smart batteries and disconnect the power supply when batteries are fully charged.

AC Power Socket on Imager

Note

Make sure that the Imager is near room temperature before you connect it to the charger. See the charging temperature specification. Do not charge in hot or cold areas. When you charge in extreme temperatures, battery capacity may be decreased. When you charge in extreme temperatures, the battery may not charge.

To charge the battery with the ac power socket on the Imager:

1. Connect the ac power adapter into an ac wall outlet and connect the other end to the ac power socket on the Imager.  flashes on the display while the battery charges.
2. Charge until the charge indicator on the display does not flash.

If you remove the Imager from the charger before a full charge shows, it can have a reduced run-time.

3. Disconnect the ac power adapter when the smart battery is fully charged.

Optional 12 V Vehicle Charger

Caution

To prevent damage to the Imager, remove it from the dc car charger before you start or jump start the vehicle.

To use the 12 V vehicle charger to charge the battery:

1. Connect the 12 V adapter into the 12 V accessory socket of the vehicle.
2. Connect the other end to the ac power socket of the Imager.

 flashes on the display while the battery charges.

3. Charge until the charge indicator on the display does not flash.
4. Disconnect the 12 V adapter and Imager when battery is fully charged.

Radio Frequency Data

See [Table 15](#) for instructions on how to access digital copies of the Certificate IDs on the Imager.

To view the Radio Frequency Data Class A Instruction Sheet, visit <http://us.fluke.com/usen/support/manuals> and search for *Radio frequency*.

Specifications

Complete specifications are at www.fluke.com. See the *TiS55+/TiS75+ Product Specifications*.