

709/709H/710

Precision Loop Calibrator

Go to www.fluke.com to register your Product, read the Users Manual and find more information.

Vaya a www.fluke.com para registrar el producto, descargar manuales y obtener más información.

Acesse www.fluke.com.br para registrar seu Produto, ler o Manual do Usuário e obter mais informações.

⚠️⚠️ Warning

To prevent possible electrical shock, fire, or personal injury, read the *709/709H Safety Information* before you use this Product.

MENU

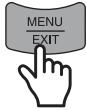

mA Source
 mA Simulate
 mA Measure
 mA Measure with 24V
 Volts Measure
 Calibrator Setup Menu
 HART Comm. Menu

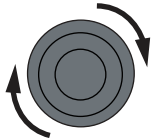

mA Source
 mA Simulate
 mA Measure
 mA Measure with 24V
 Volts Measure
 Calibrator Setup Menu
 HART Comm. Menu

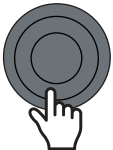

mA Source
 mA Simulate
 mA Measure
 mA Measure with 24V
 Volts Measure
 Calibrator Setup Menu
 HART Comm. Menu

mA Source

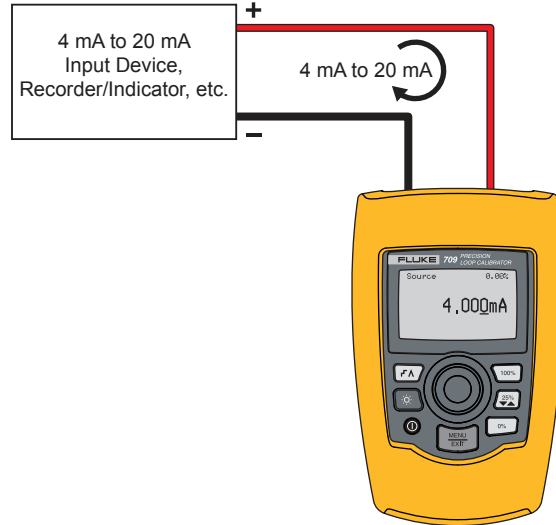

mA Measure

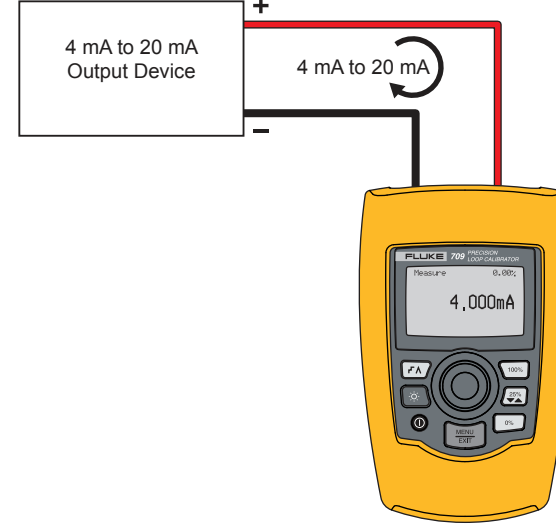

Volt Measure

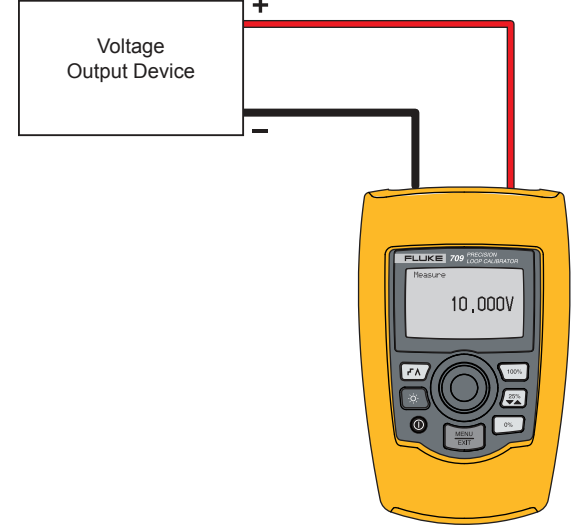

mA Simulate

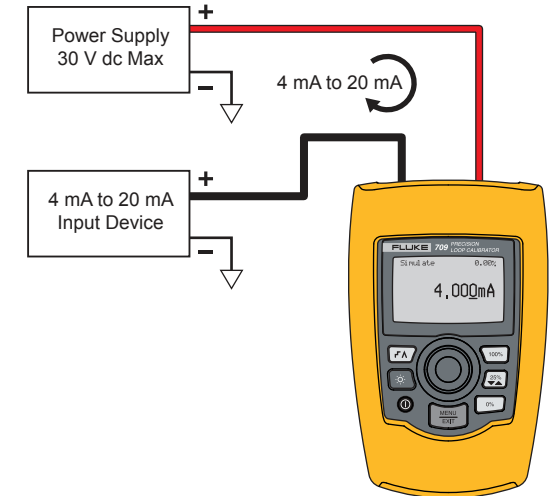

mA Measure with 709H Loop Power

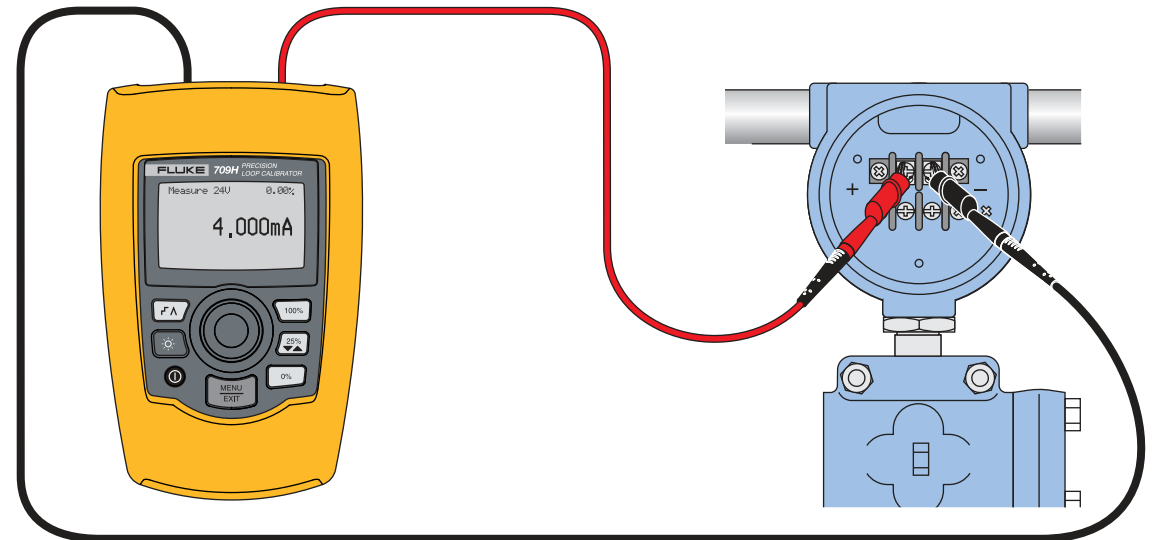

In Circuit, External Loop Power

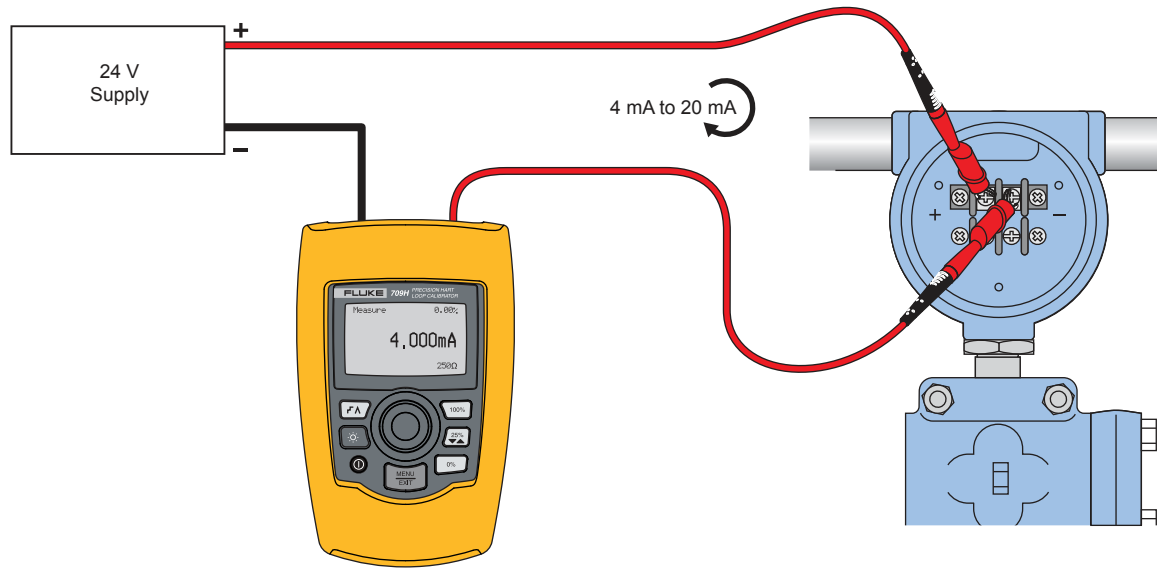

Across Circuit, Communicator Only

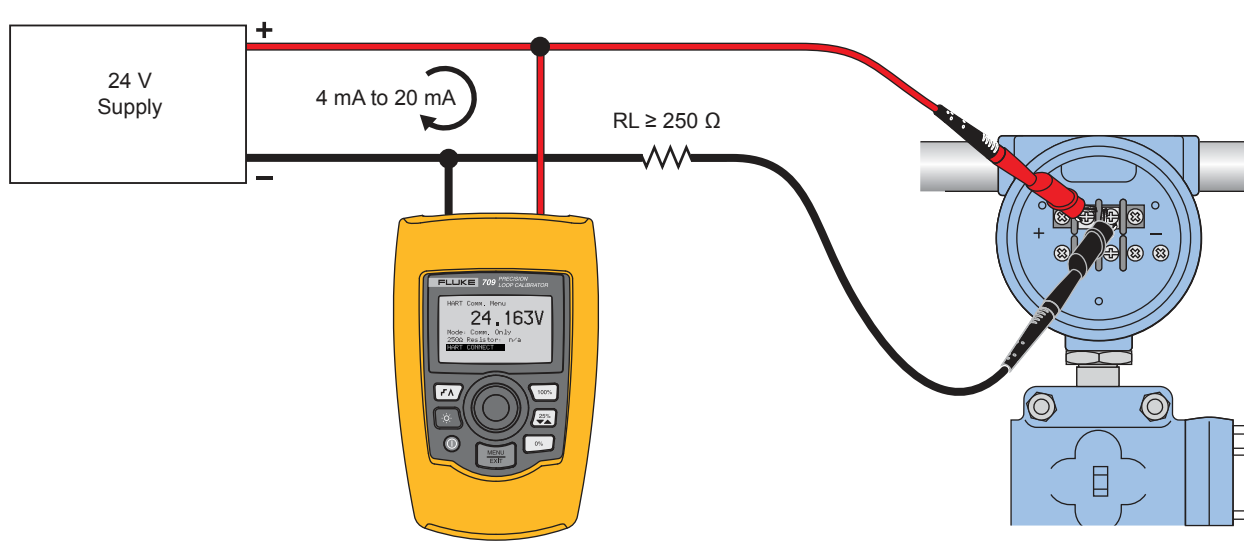

HART, 710 Valve Test

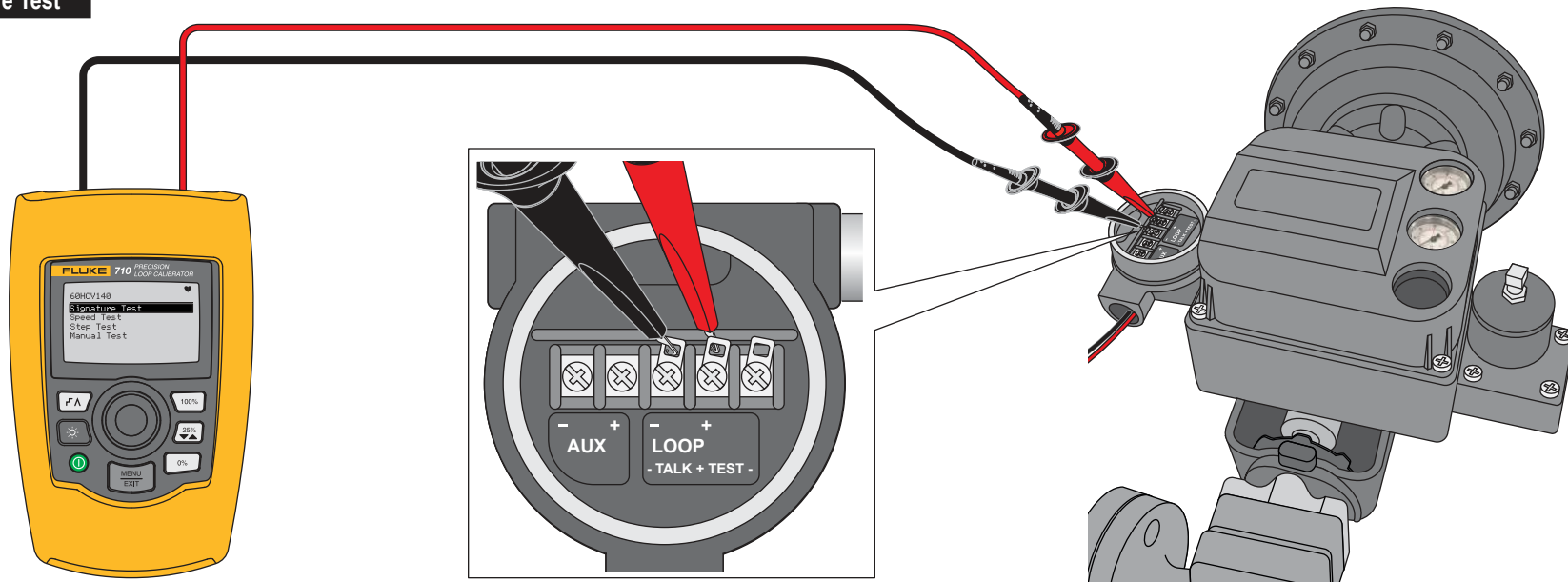

Battery

