

1623-2

Earth/Ground Tester

Users Manual

January 2014

© 2014 Fluke Corporation. All rights reserved. Specifications are subject to change without notice.
All product names are trademarks of their respective companies.

LIMITED WARRANTY AND LIMITATION OF LIABILITY

Each Fluke product is warranted to be free from defects in material and workmanship under normal use and service. The warranty period is two years and begins on the date of shipment. Parts, product repairs, and services are warranted for 90 days. This warranty extends only to the original buyer or end-user customer of a Fluke authorized reseller, and does not apply to fuses, disposable batteries, or to any product which, in Fluke's opinion, has been misused, altered, neglected, contaminated, or damaged by accident or abnormal conditions of operation or handling. Fluke warrants that software will operate substantially in accordance with its functional specifications for 90 days and that it has been properly recorded on non-defective media. Fluke does not warrant that software will be error free or operate without interruption.

Fluke authorized resellers shall extend this warranty on new and unused products to end-user customers only but have no authority to extend a greater or different warranty on behalf of Fluke. Warranty support is available only if product is purchased through a Fluke authorized sales outlet or Buyer has paid the applicable international price. Fluke reserves the right to invoice Buyer for importation costs of repair/replacement parts when product purchased in one country is submitted for repair in another country.

Fluke's warranty obligation is limited, at Fluke's option, to refund of the purchase price, free of charge repair, or replacement of a defective product which is returned to a Fluke authorized service center within the warranty period.

To obtain warranty service, contact your nearest Fluke authorized service center to obtain return authorization information, then send the product to that service center, with a description of the difficulty, postage and insurance prepaid (FOB Destination). Fluke assumes no risk for damage in transit. Following warranty repair, the product will be returned to Buyer, transportation prepaid (FOB Destination). If Fluke determines that failure was caused by neglect, misuse, contamination, alteration, accident, or abnormal condition of operation or handling, including overvoltage failures caused by use outside the product's specified rating, or normal wear and tear of mechanical components, Fluke will provide an estimate of repair costs and obtain authorization before commencing the work. Following repair, the product will be returned to the Buyer transportation prepaid and the Buyer will be billed for the repair and return transportation charges (FOB Shipping Point).

THIS WARRANTY IS BUYER'S SOLE AND EXCLUSIVE REMEDY AND IS IN LIEU OF ALL OTHER WARRANTIES, EXPRESS OR IMPLIED, INCLUDING BUT NOT LIMITED TO ANY IMPLIED WARRANTY OF MERCHANTABILITY OR FITNESS FOR A PARTICULAR PURPOSE. FLUKE SHALL NOT BE LIABLE FOR ANY SPECIAL, INDIRECT, INCIDENTAL OR CONSEQUENTIAL DAMAGES OR LOSSES, INCLUDING LOSS OF DATA, ARISING FROM ANY CAUSE OR THEORY.

Since some countries or states do not allow limitation of the term of an implied warranty, or exclusion or limitation of incidental or consequential damages, the limitations and exclusions of this warranty may not apply to every buyer. If any provision of this Warranty is held invalid or unenforceable by a court or other decision-maker of competent jurisdiction, such holding will not affect the validity or enforceability of any other provision.

Fluke Corporation
P.O. Box 9090
Everett, WA 98206-9090
U.S.A.

Fluke Europe B.V.
P.O. Box 1186
5602 BD Eindhoven
The Netherlands

11/99

To register your product online, visit register.fluke.com.

Table of Contents

Title	Page
Introduction	1
How to Contact Fluke.....	1
Safety Information	2
Storage.....	3
Models and Accessories	4
Additional Accessories	5
Features	6
Display	7
Setup.....	8
Batteries.....	8
Description of Functions	10
Operation	11
R _A 2-Pole, 3-Pole Measurements.....	11
R _A 4-Pole Measurements	13
R _A 3-Pole Selective Earth Resistance Measurement with Current Clamp.....	15
R _A 4-Pole Selective Earth Resistance Measurement with Current Clamp.....	17
Stakeless Ground Loop Measurement.....	19
Advanced Operation	21
Measurements on High Voltage Pylons	21
Measurement of Soil Resistivity	24
Export Stored Data to PC	26
Delete Stored Data.....	26
How to Troubleshoot.....	27
Maintenance.....	29
Calibration	29
Service	29
Specifications	30

List of Tables

Table	Title	Page
1.	Symbols.....	3
2.	Models and Accessories	4
3.	Features and Functions.....	6
4.	Display.....	7
5.	Sample .CSV File for Logged Data	26
6.	Troubleshooting.....	27

List of Figures

Figure	Title	Page
1.	External Current Transformer EI-162BN	5
2.	Battery Insertion	9
3.	R _A 2-Pole Measurement	12
4.	R _A 3-Pole Measurement	12
5.	R _A 4-Pole Measurements	14
6.	R _A 3-Pole Selective Earth Resistance Measurement with Current Clamp.....	16
7.	R _A 4-Pole Selective Earth Resistance with Current Clamp.....	18
8.	Stakeless Ground Loop Measurement.....	20
9.	Earthing Resistance without Disengaging the Overhead Earth Wire.....	21
10.	Measurement of Soil Resistivity	24
11.	Troubleshooting.....	28

Introduction

The 1623-2 Earth Ground Tester (Tester or Product) is a compact, field-rugged instrument that performs all four types of earth ground measurement. Specifically, the Tester is able to measure earth ground loop resistances using only clamps – called Stakeless testing. This method doesn't require the use of earth ground stakes or the disconnection of ground rods.

The 1623-2 features:

- One-button measurement concept
- 3-pole and 4-pole earth ground measurement
- 4-pole soil resistivity testing
- Selective testing, no disconnection of ground conductor (1 clamp)
- Stakeless testing, quick ground loop testing (2 clamps)
- Measuring frequency 128 Hz

How to Contact Fluke

To contact Fluke, use one of these telephone numbers:

- USA: 1-800-760-4523
- Canada: 1-800-36-FLUKE (1-800-363-5853)
- Europe: +31 402-675-200
- Japan: +81-3-6714-3114
- Singapore: +65-6799-5566
- Anywhere in the world: +1-425-446-5500

Go to www.fluke.com to register your product, download manuals, and find more information.

To view, print, or download the latest manual supplement, visit

<http://us.fluke.com/usen/support/manuals>.

Safety Information

A **Warning** identifies hazardous conditions and procedures that are dangerous to the user. A **Caution** identifies conditions and procedures that can cause damage to the Product or the equipment under test.







Warning

To prevent possible electrical shock, fire, or personal injury:

- Read all safety information before you use the Product.
- Use the Product only as specified, or the protection supplied by the Product can be compromised.
- Do not use the Product if it operates incorrectly.
- Do not use the Product if it is damaged.
- Do not use test leads if they are damaged. Examine the test leads for damaged insulation, exposed metal, or if the wear indicator shows. Check test lead continuity.
- Do not use the Product around explosive gas, vapor, or in damp or wet environments.
- Do not apply more than the rated voltage, between the terminals or between each terminal and earth ground.
- Use only current probes, test leads, and adapters supplied with the Product.
- Do not use a current measurement as an indication that a circuit is safe to touch. A voltage measurement is necessary to know if a circuit is hazardous.
- The battery door must be closed and locked before you operate the Product.
- Replace the batteries when the low battery indicator shows to prevent incorrect measurements.
- Do not connect directly to mains.
- Do not touch voltages >30 V ac rms, 42 V ac peak, or 60 V dc.

Table 1 is a list of symbols used on the Tester and in this manual.

Table 1. Symbols

Symbol	Description
	Risk of Danger. Important information. See Manual.
	Hazardous voltage. Risk of electrical shock.
	Battery Indicator
	Conforms to European Union directives.
	Conforms to relevant South Korean EMC Standards.
	Conforms to relevant Australian EMC requirements.
	This product complies with the WEEE Directive (2002/96/EC) marking requirements. The affixed label indicates that you must not discard this electrical/electronic product in domestic household waste. Product Category: With reference to the equipment types in the WEEE Directive Annex I, this product is classed as category 9 "Monitoring and Control Instrumentation" product. Do not dispose of this product as unsorted municipal waste. Go to Fluke's website for recycling information.

Storage

If the Tester is stored for an extended period of time or is not in use for a long time, you should remove the batteries.

Models and Accessories

These standard accessories were shipped with your Tester:

- 6 alkaline AA – type (LR6) batteries
- 2 measuring leads 1.5 m
- 1 connector cable (for RA 2-pole measurements)
- 2 alligator clips
- 1 Documentation CD with Users Manual
- Quick Reference Guide
- Safety Information

Table 2 lists the models and accessories.

Table 2. Models and Accessories

Description	Part Number
1623-2 Earth Ground Tester (Includes Users Manual, Safety Information, QRG, Geox Probe Cable, 2 clips, Lead set)	4325155
1623-2 Earth Ground Tester Kit (Includes Users Manual, Safety Information, QRG, Geox Probe Cable, 2 clips, Lead set, 4 Earth Stakes, 3 Cable Reels, C1620 Carrying Case, EI-162X & EI-162AC)	4325170
162x-7001 Service Replacement Kit (Includes Lead set & 2 clips)	2577167
Earth Stake	4325492
ES-162P3-2 Stake Set for 3 Pole Measurement (Includes 3 Earth Stakes, 1 Cable Reel 25M Blue, 1 Cable Reel 50M Red)	4359377
ES-162P4-2 Stake Set for 4 Pole Measurement (Includes 4 Earth Stakes, 1 Cable Reel 25M Blue, 1 Cable Reel 25M Green, 1 Cable Reel 50M Red)	4359389
EI-1623 Selective/Stakeless Clamp Set for 1623-2/1625-2 (Includes EI-162X, EI-162AC)	2577115
EI-162X Clip-on Current Transformer (sensing) with shielded cable set	2577132
EI-162AC Clip-on Current Transformer (inducing)	2577144
EI-162BN Split Core Transformer - for Pylon Testing (12.7 inch - 320 mm)	2577159
Shielded Cable (Used w/ EI-162X Clamp)	2630254
Cable Reel, 25M, Blue wire	4343731
Cable Reel, 25M, Green wire	4343746
Cable Reel, 50M, Red wire	4343754
C1620 Carrying Case	4359042

Additional Accessories

An **external current transformer** is available as an option, see Figure 1. The transformer has a transformation ratio between 80 and 1200:1 for the measurement of a single branch in mesh-operated earthing systems. This enables the user to measure on high voltage pylons without separating the overhead earth wires or earth strips at the bottom of the pylons. It is also used to measure lightning protection systems without separating the individual lightning protection wires.

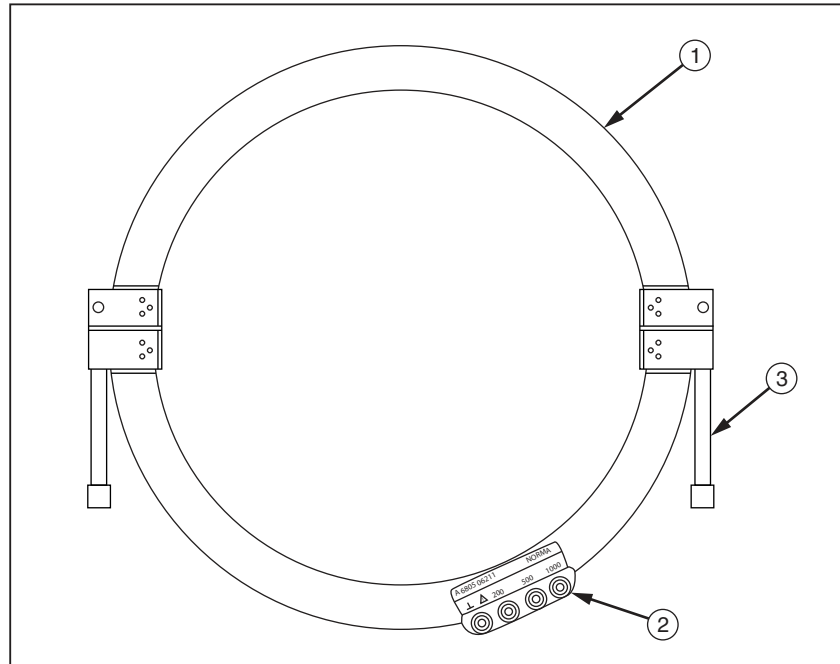

evx01.eps

Figure 1. External Current Transformer EI-162BN

- ① Transformer half (2)
Transformer end faces have bolts that pivot to aid in separating the Transformer halves. One Transformer end face has a slotted bolt hole that allows the bolt to pivot out of the end face.
- ② Transformation ratio connections: \perp , 200, 500, and 1000
- ③ Fastener (2)

Features

Typical applications for the Tester include:

- Earth/ground resistance measurements in different installations, such as, high voltage pylons, buildings, electrical service grounding systems, mobile communication stations, and HF transmitters.
- Monitor and plan lightning protection systems
- Resistance measurements with earth electrodes; no separation

See Table 3 for a list of features and functions.

Table 3. Features and Functions

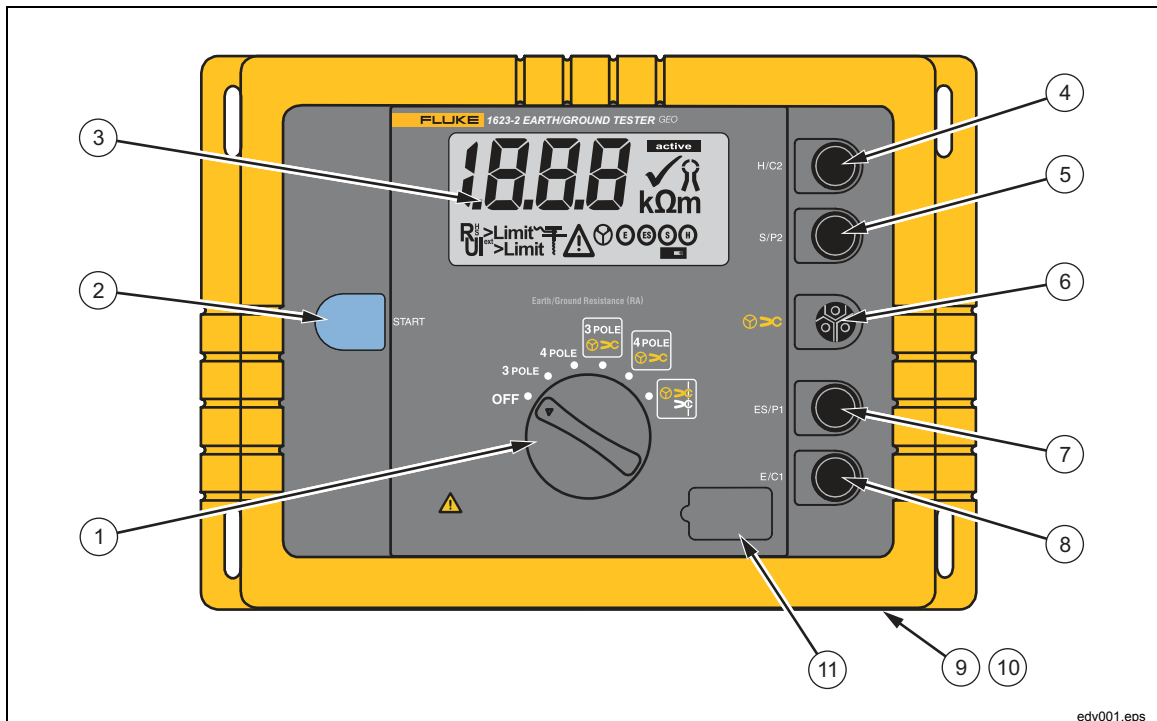

Item	Description
①	Rotary switch to select measurement function and ON/OFF
②	“START” button to start the selected measurement function
③	Liquid crystal display (LCD)
④	Connection “H/C2” for auxiliary earth (4 mm Ø)
⑤	Connection “S/P2” for probe (4 mm Ø)
⑥	Connection  for sense current test clamp
⑦	Connection “ES/P1” for earth electrode probe (4 mm Ø)
⑧	Connection “E/C1” for the earth/ground electrode to be measured (4 mm Ø)
⑨	Battery compartment for 6 alkaline batteries (type AA, LR6)
⑩	Screws to fasten the battery compartment
⑪	USB Type B Port

Display

The LCD is a 1999-digit display with special symbols and digit height of 25 mm. See Table 4 for location and description of each display element.

Table 4. Display

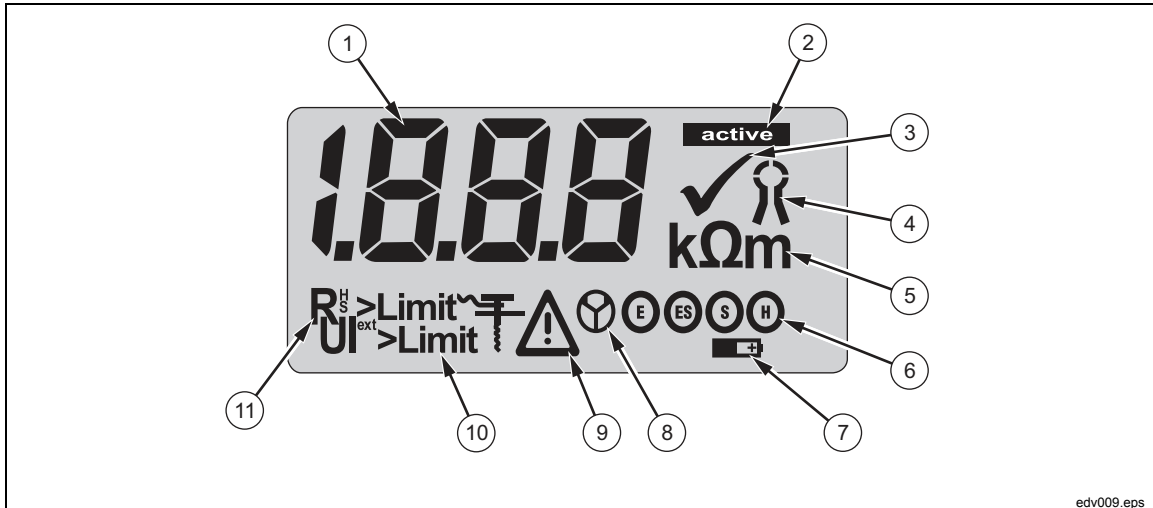

edv009.eps

Item	Description
①	Measurement value
②	Measurement in process
③	Measurement complete
④	Connection for current clamp
⑤	Measurement unit
⑥	Socket indicator
⑦	Battery voltage too low, replace batteries
⑧	Current clamp socket indicator
⑨	Error
⑩	External voltage too high/External current
⑪	RH>Limit: Auxiliary Earth electrode resistance too high
	RS>Limit: Probe resistance too high

Setup

Warning

Read the safety information before you power on the instrument. If you have problems, see *How to Troubleshoot*.

Batteries

Warning

To prevent possible electrical shock, fire, or personal injury:

- The battery door must be closed and locked before you operate the Product.
- Replace the batteries when the low battery indicator shows to prevent incorrect measurements.
- Batteries contain hazardous chemicals that can cause burns or explode. If exposure to chemicals occurs, clean with water and get medical aid.

Warning

For safe operation and maintenance of the Product:

- Repair the Product before use if the battery leaks.
- Be sure that the battery polarity is correct to prevent battery leakage.

To insert the batteries:

1. Switch off instrument, see Figure 2.
2. Disconnect all test leads.
3. Open battery compartment.
4. Insert batteries. Always replace the complete set of batteries.
5. Close battery compartment.

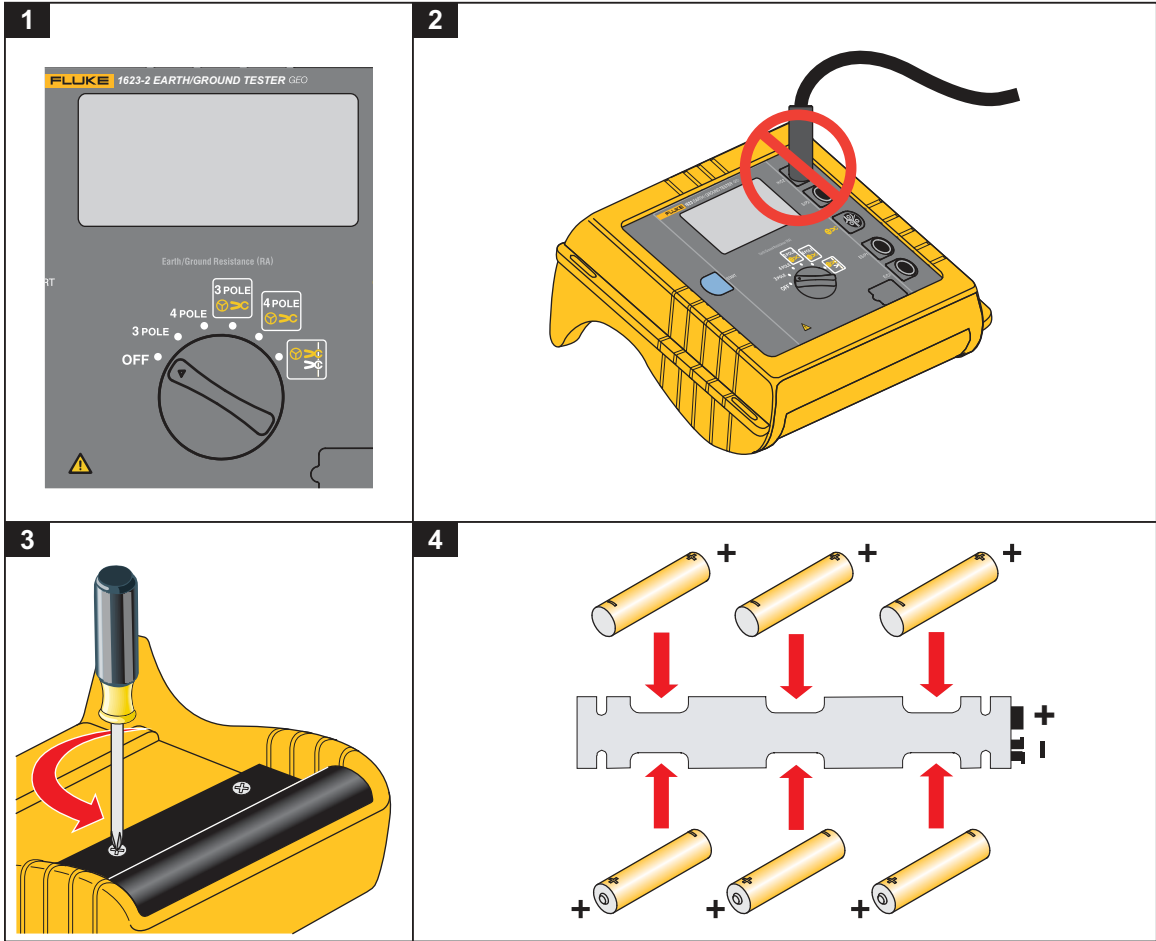

Figure 2. Battery Insertion

edv002.eps

Description of Functions

The functions are selected with the central rotary switch. Measurement values are shown on a liquid crystal display with correct decimal point and unit. Additional special characters indicate measurement mode, operating condition, and error messages.

The Tester includes these measurement functions:

- **Earthing Resistance (R_E)** The earthing resistance is determined by a 3-pole or 4-pole current and voltage measurement. The measuring voltage is a square pulse ac voltage with 48 / 20 V and a frequency of 94, 105, 111 or 128 Hz. The frequency can be selected manually or automatically (AFC).
- **Selective Measurement of Earthing (R_E \gg C)** Measurement of a single earth electrode in a mesh operated (parallel) earthing system. The current flowing through the single earth electrode is measured with an external current transformer.
- **Low Battery Indicator** Battery voltage is low, replace batteries.

Operation

The Tester is equipped with a 3-pole as well as a 4-pole resistance measurement that renders measurements of resistances of earthing systems and measurements of the soil resistivity of geological strata. The Tester also makes measurements with an external current transformer, with which a measurement of single resistance branches in interlinked networks (lightning protection and high voltage pylons with cabling) can be performed without separating parts of the system.

R_A 2-Pole, 3-Pole Measurements

To make 2-pole or dead-earth measurements, connect a jumper between terminals H/C2 and S/P2 with the supplied connector cable. Use only the earth electrode and the auxiliary earth electrode. Minimum distance between earth electrode (E/CD1) and auxiliary earth (H/C2) should be at least 20 m.

See Figures 3 and 4 and do steps 1 thru 4:

1. Select **3 POLE**.
2. Connect the test leads.

Connect terminal E/C1 to the earth/ground system to be measured with the supplied test lead and clip (1.5 m). Place two ground stakes in earth/dirt.

Note

Minimum distance between earth electrode (E/C1), probe (S/P2), and auxiliary earth (H/C2) should be at least 20 m.

Connect the stakes with the 25 m and 50 m cable reels to H/C2 and S/P2 as shown in Figures 3 and 4.

3. Push **START**.
active indicates that a measurement is in progress. For a continuous measurement, continue to push the START button.
4. ✓ indicates a completed measurement. The result is kept on the display until a new measurement is started or the main switch is turned.

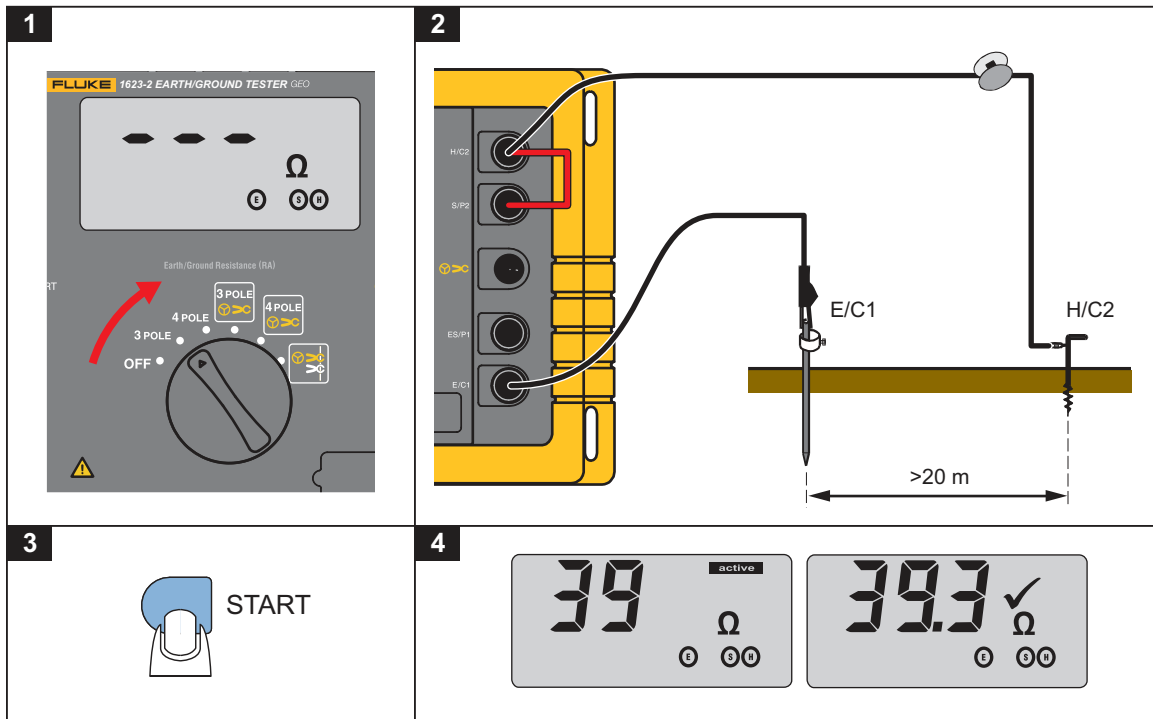

Figure 3. RA 2-Pole Measurement

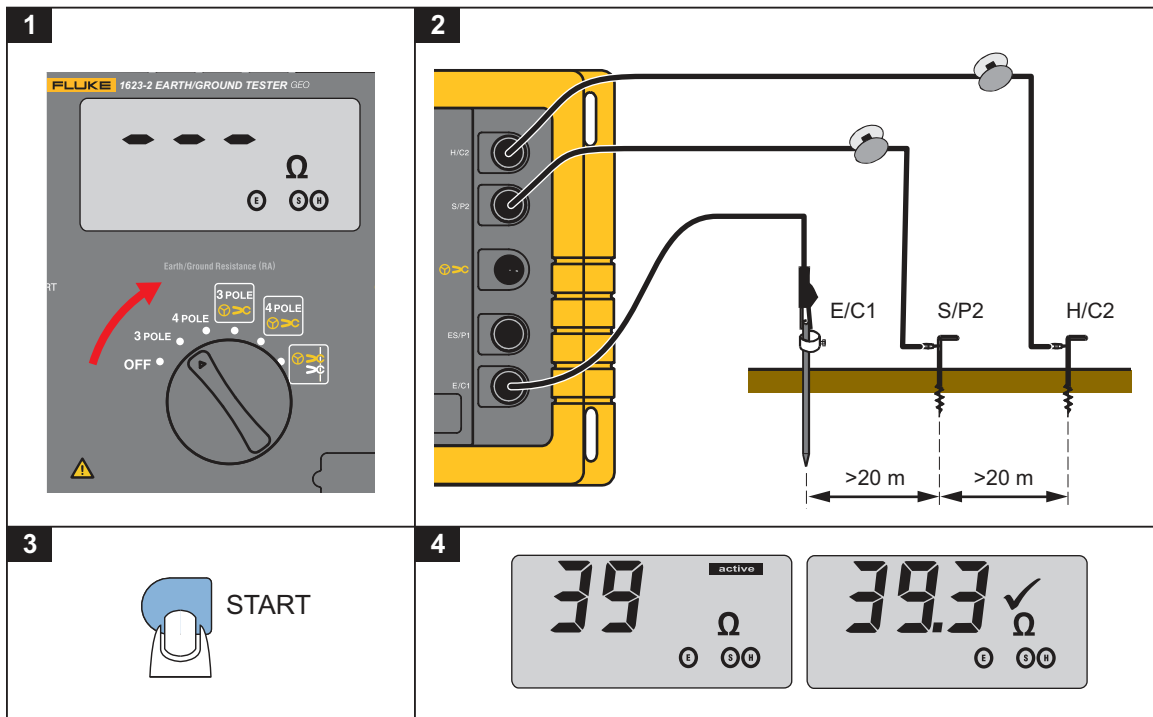

Figure 4. RA 3-Pole Measurement

R_A 4-Pole Measurements

To make 4-pole measurements:

1. Select **4 POLE** function. See Figure 5.

2. Connect test leads.

Connect terminals E/C1 and ES/P1 to the earth system to be measured with the two supplied test leads (1.5 m). Place two ground stakes in earth/dirt. Minimum distance between earth electrode (E/C1), probe (S/P2), and auxiliary earth (H/C2) should be at least 20 m. The ES test lead eliminates the influence of the test leads.

Connect the stakes with the 25 m and 50 m cable reels to H/C2 and S/P2 as shown below.

3. Push **START**.

active indicates that a measurement is in progress. For a continuous measurement, continue to push the START button.

4. ✓ indicates a completed measurement. The result is kept on the display until a new measurement is started or the rotary switch is turned.

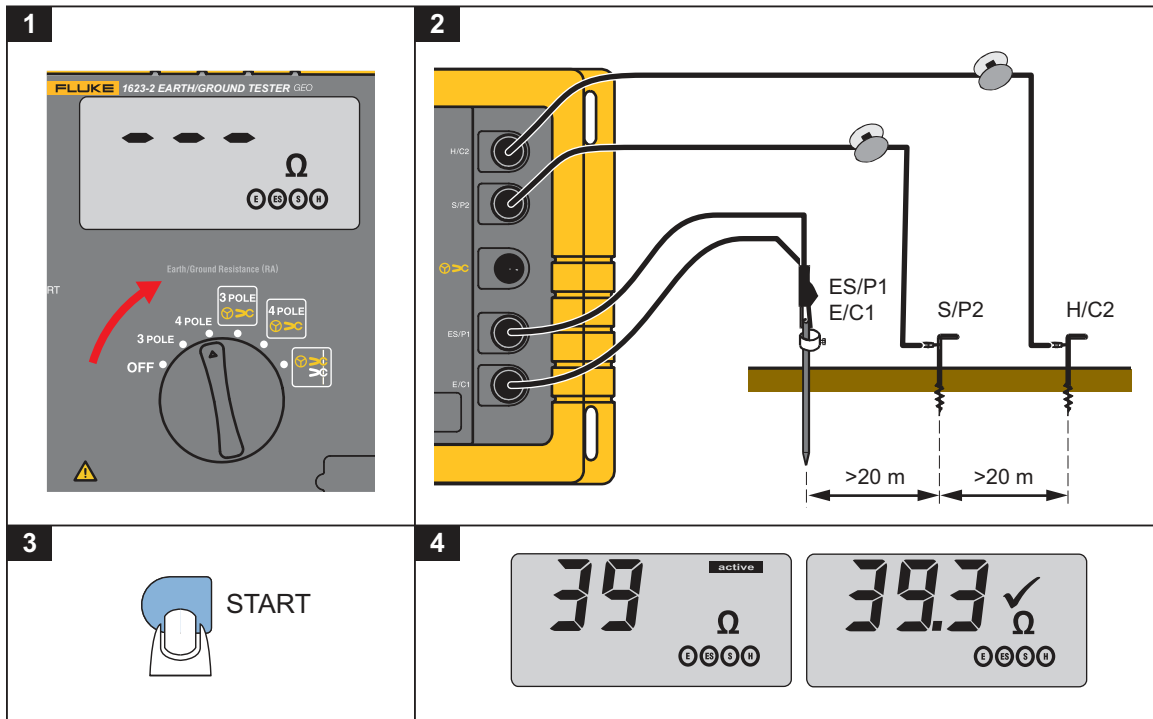

Figure 5. R_A 4-Pole Measurements

edv004.eps

R_A 3-Pole Selective Earth Resistance Measurement with Current Clamp

The R_A 3-pole Selective Earth Resistance Measurement with Current Clamp procedure is useful for the resistance measurement of different parallel sections of an earth/ground system.

1. Select **3 POLE**  . See Figure 6.

2. Connect test leads.

Connect the supplied test lead (1.5 m) to terminal E/C1 and its other end to the ground system to be measured. Place two ground stakes in earth/dirt. Minimum distance between earth electrode (E/C1), probe (S/P2) and auxiliary earth (H/C2) should be at least 20 m.

Connect stakes with 25 m and 50 m wires to H/C2 and S/P2 as shown.

Connect current clamp with adapter cable as shown.

3. Push **START**.

active indicates that measurement is in progress. For continuous measurement, continue to push the START button.

4. ✓ indicates completed measurement. The result is kept on display until a new measurement is started or the rotary switch is turned.

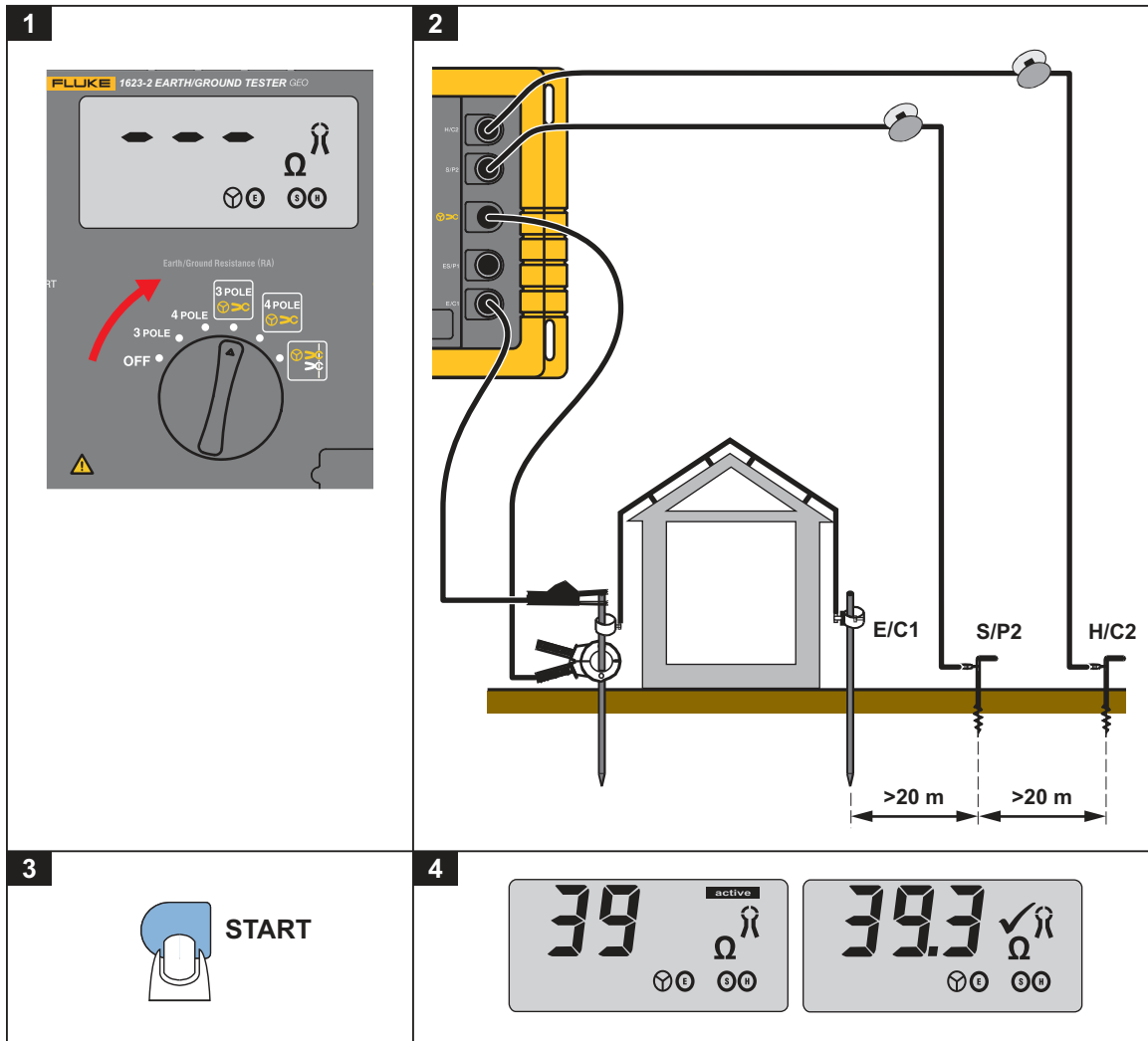

Figure 6. R_A 3-Pole Selective Earth Resistance Measurement with Current Clamp

edv005.eps

R_A 4-Pole Selective Earth Resistance Measurement with Current Clamp

The R_A 4-pole Selective Earth Resistance Measurement with Current Clamp procedure is useful for the resistance measurement of different parallel sections of an earth/ground system.

1. Select function **4 POLE**  **>C**. See Figure 7.

2. Connect test leads.

Connect terminals E/C1 and ES/P1 with the supplied safety test leads (1.5 m) to the earth electrode to be measured. Place two ground stakes in earth/dirt. Minimum distance between earth electrode (E/C1), probe (S/P2) and auxiliary earth (H/C2) should be a minimum 20 m. The  test lead eliminates the influence of the test leads.

Connect stakes with 25 m and 50 m wires to H/C2 and S/P2 as shown.

Connect current clamp with adapter cable as shown.

3. Push **START**.

active indicates that measurement is in progress. For continuous measurement, continue to push the START button.

4.  indicates completed measurement. The result is kept on display until a new measurement is started or the rotary switch is turned.

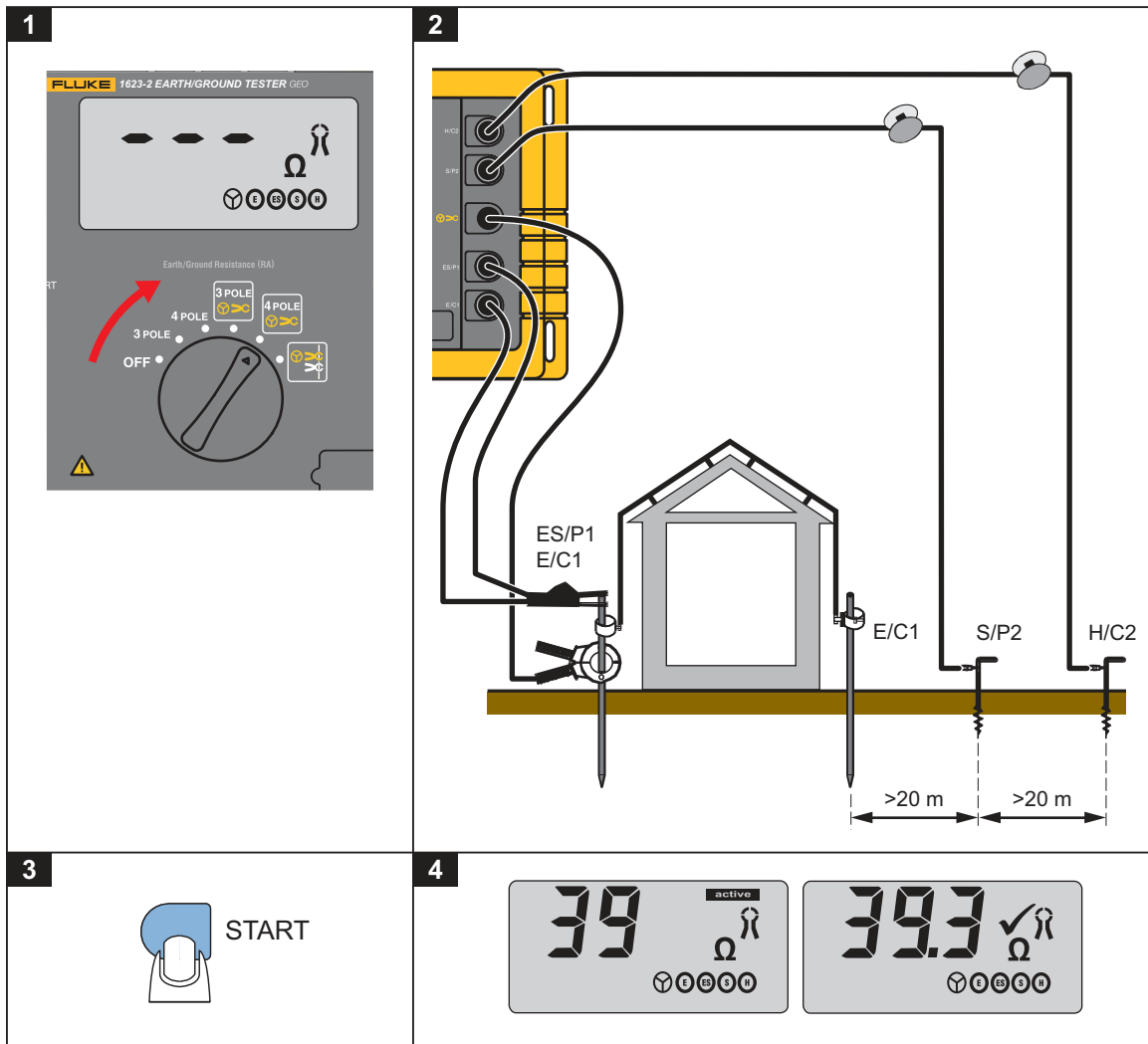

edv006.eps

Figure 7. RA 4-Pole Selective Earth Resistance Measurement with Current Clamp

Stakeless Ground Loop Measurement

With this test method, two clamps are placed around the earth ground rod or the connecting cable and each are connected to the Tester. Earth ground stakes are not used. A known voltage is induced by one clamp, and the current is measured with the second clamp. The tester automatically determines the ground loop resistance at this ground rod.

1. Select . See Figure 8.

2. Connect current clamps.

Connect the inducing clamp (see *Models and Accessories*) to terminals H/C2 and E/C1 with the supplied safety test leads (1.5 m) as shown.

Note

*Use the recommended current clamp for inducing only.
Other current clamps are not suited.*

Connect the second current clamp using the adapter cable (sensing current clamp).

Clamp both current clamps around the earth electrode, which will subsequently be measured.

Note

*Minimum distance between the two current clamps is
10 cm.*

3. Push **START**.

active indicates that measurement is in progress. For continuous measurement, continue to push the START button.

4. ✓ indicates completed measurement. The result is kept on display until a new measurement is started or the rotary switch is turned.

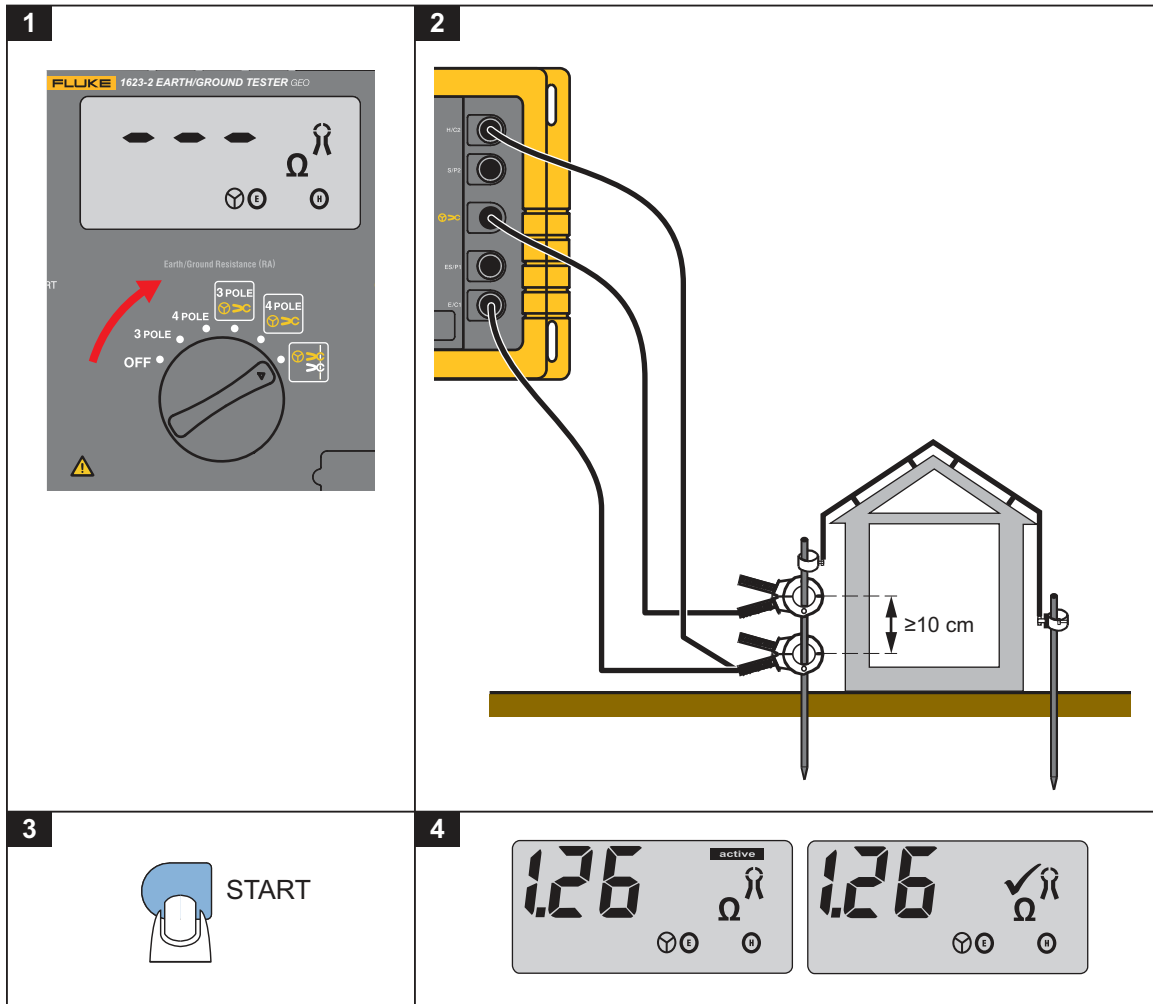

Figure 8. Stakeless Ground Loop Measurement

edv007.eps

Advanced Operation

The Tester uses advanced features to measure earth resistance of a single high voltage pylon and soil resistivity for calculation and design of earthing systems.

Measurements on High Voltage Pylons

The measurement of the earth resistance of a single high voltage pylon usually requires the overhead earth wire to be disengaged (lifted off) or the separation of the earthing system from the pylon construction. Otherwise, false reading of the resistance of the pylon earth electrode are liable to occur because of the parallel circuit of the other pylons connected to each other by an overhead earth wire.

The new measuring method employed in this instrument - with its external current transformer to measure the true current flowing through the earth electrode - allows measurements of earth electrode resistances without disconnection of the earthing system or disengaging the overhead earth wire. See Figure 9.

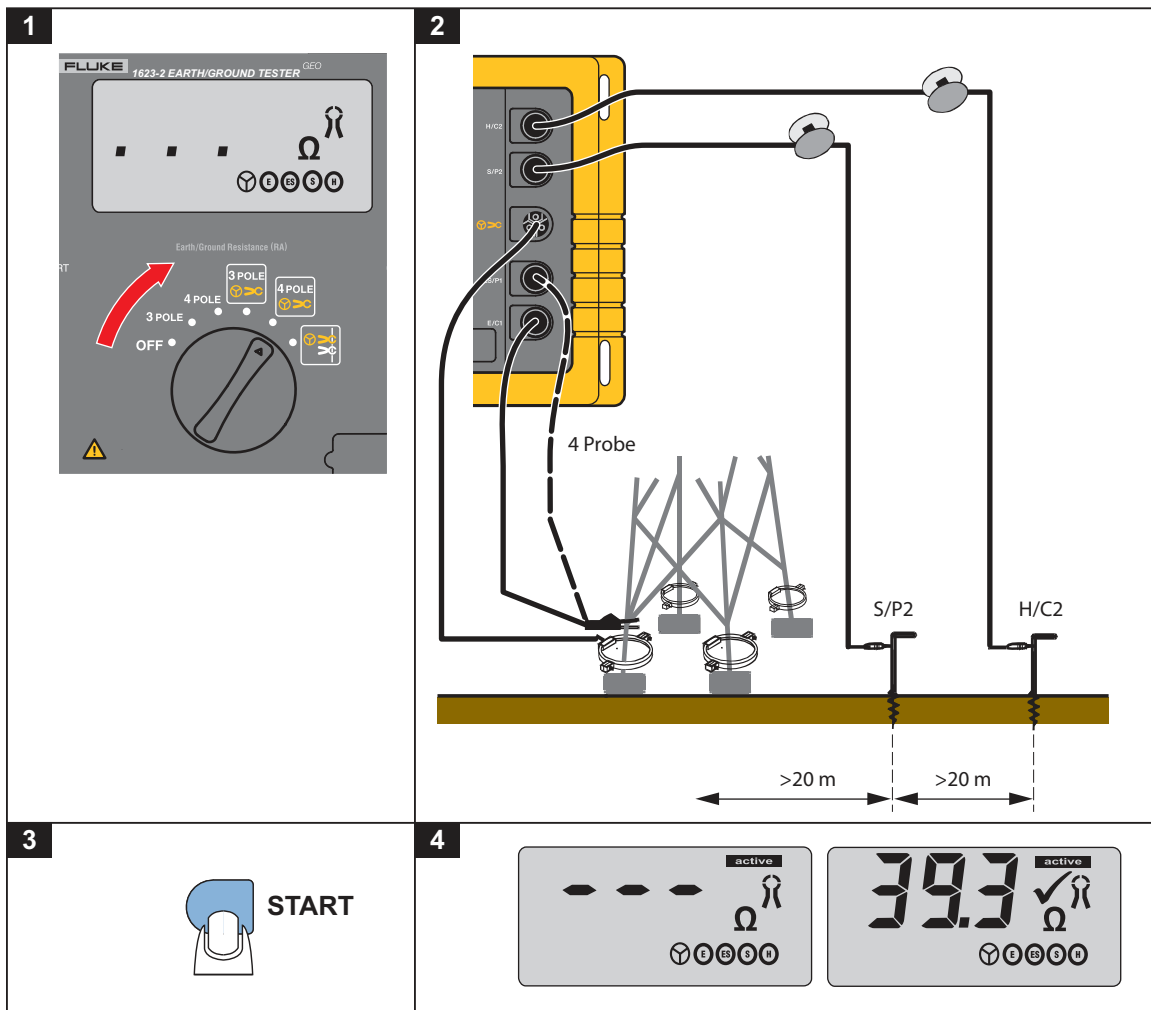

Figure 9. Earthing Resistance without Disengaging the Overhead Earth Wire

edv016.eps

As all four pylon stubs are connected to the foundation earth of the pylon, the measuring current I_{meas} is divided into five components according to the present resistances involved.

One part flows via pylon construction to the overhead earth wire and further to the parallel circuited pylon earthing resistances.

The other four current components ($I_1... I_4$) flow via the individual pylon foots.

The addition of all currents result in a current I_E going through the earthing resistance, for example, the resistance of the "composite" earth electrode to the soil.

If the current transformer is fixed to each pylon stub, one after the other, four resistances have to be measured which show a behavior inversely proportional to the corresponding current components $I_1 ... I_4$. The feeding point of the measuring current is to be left unchanged to avoid a change in the current distribution.

Accordingly, these equivalent resistances are displayed as:

$$R_{Ei} = \frac{U_{meas}}{I_i}$$

Therefore the earthing resistance R_E of the pylon is determined as a parallel circuit of the individual equivalent resistances:

$$R_E = \frac{1}{\frac{1}{R_{E1}} + \frac{1}{R_{E2}} + \frac{1}{R_{E3}} + \frac{1}{R_{E4}}}$$

1. Turn central rotary switch to position "**➤**CR_E 3pole" or "**➤**CR_E 4pole". The instrument is to be wired according to picture and messages on the display.
2. Apply current transformer to the pylon stub.
3. Push **START**.

Now a fully automated test sequence of all relevant parameters like auxiliary earth electrode, probe and earth electrode resistances is implemented and finishes with the display of the result R_E .

4. Read out measured value R_E .

Note

Before setting the earth stakes for probe and auxiliary earth electrode make sure that the probe is set outside the potential gradient of earth electrode and auxiliary earth electrode. Such a condition is normally reached by allowing a distance of >20 m between the earth electrode and the earth stakes as well as to the earth stakes to each other. An accuracy test of the results is made with another measurement after repositioning of auxiliary earth electrode or probe. If the result is the same, the distance is sufficient. If the measured value changes, probe or auxiliary earth electrode must be repositioned until the measured value R_E remains constant.

Stake wires should not run too close.

5. Apply current transformer to next pylon stub.
6. Repeat measuring sequence.

Current feeding point of measuring current (alligator clip) and the polarity of the split core current transformer has to be left unchanged.

After values of R_{Ei} of all pylon foots are determined, the actual earth resistance R_E has to be calculated:

$$R_E = \frac{1}{\frac{1}{R_{E1}} + \frac{1}{R_{E2}} + \frac{1}{R_{E3}} + \frac{1}{R_{E4}}}$$

Note

If the displayed R_E value is negative despite correct orientation of the current transformer, a part of the measuring current is flowing upwards into the tower body. The earthing resistance, thus coming into effect, correctly calculates if the individual equivalent resistances (under observation of their polarity) are inserted into the equation above.

Measurement of Soil Resistivity

The soil resistivity is the geological and physical quantity for calculation and design of earthing systems. The measuring procedure shown in Figure 10 uses the method developed by Wenner (F. Wenner, A method of measuring earth resistivity; Bull. National Bureau of Standards, Bulletin 12 (4), Paper 258, S 478-496; 1915/16).

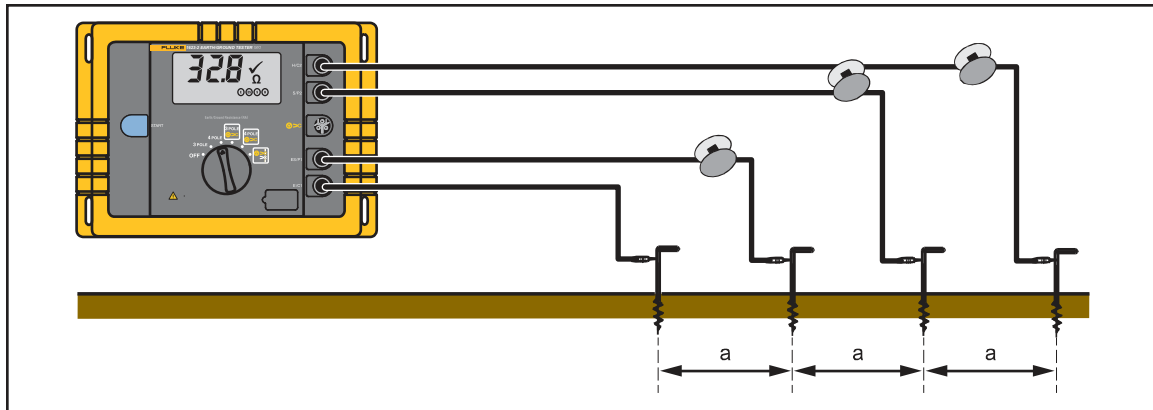

Figure 10. Measurement of Soil Resistivity

edv020.eps

1. Four earth stakes of the same length are positioned into the soil in an even line and with the same distance "a" to each other. The earth stakes should not be hammered in deeper than a maximum of 1/3 of "a".
2. Turn central rotary switch to position "R_E 4pole".
The instrument is to be wired according to picture and notices given on the display.
3. Push **START**.
4. Read out measured value R_E.

From the indicated resistance value R_E , the soil resistivity calculates according to the equation:

$$\rho_E = 2\pi \cdot a \cdot R_E$$

ρ_E mean value of soil resistivity (Ωm)

R_E measured resistance (Ω)

a probe distance (m)

The measuring method according to Wenner determines the soil resistivity down to a depth of approx. the distance "a" between two earth stakes. By increasing "a", deeper strata can be measured and checked for homogeneity. By changing "a" several times, a profile can be measured from which a suitable earth electrode can be determined.

According to the depth to be measured, "a" is selected between 2 m and 30 m. This procedure results in curves depicted in the graph below.

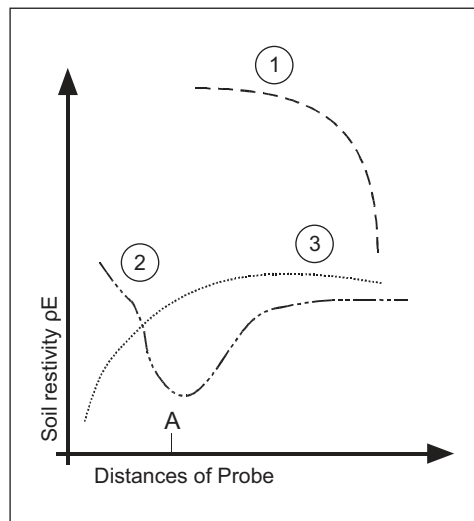

edw021.eps

Curve 1: As ρ_E decreases only deeper down, a deep earth electrode is advisable

Curve 2: As ρ_E decreases only down to point A, an increase in the depth deeper than A does not improve the values.

Curve 3: With increasing depth ρ_E is not decreasing: a strip conductor electrode is advisable.

As measuring results are often distorted and corrupted, for example, by underground pieces of metal and underground aquifers, a second measurement, in which the stake axis is turned by an angle of 90° , is always advisable (see graph below).

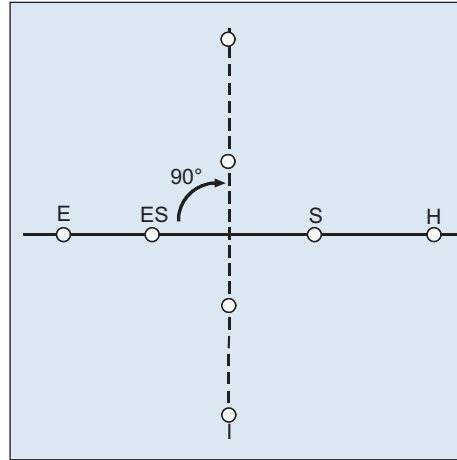

edw022.eps

Export Stored Data to PC

Test data is automatically stored for all tests as a .csv file. Table 5 is an example of the .csv file.

To export data from the Tester to a PC:

1. Connect the USB cable from the Tester to the PC.
2. Use Windows Explorer on the PC to find new **EGT drive** in the Devices list.
3. Locate the Data.csv file on the EGT drive.
4. Use the standard PC tools to copy the file to a new location.

Table 5. Sample .CSV File for Logged Data

Measurement	Timestamp	Measurement Mode	Earth Ground Resistance R_E	Error Status
1	15th Oct 2013 20:13:55	3-pole R_E	1.022 Ω	NA
2	15th Oct 2013 20:13:55	4-pole R_E	1.022 Ω	NA
3	15th Oct 2013 20:13:55	3-pole Selective	1.022 Ω	NA
4	15th Oct 2013 20:13:55	4-pole R_E	NA	Rh Limit

Delete Stored Data

To delete stored data in the Tester:

1. Connect the USB cable from the Tester to the PC.
2. Use Windows Explorer on the PC to find new **EGT drive** in the Devices list.
3. Locate the Data.csv file on the EGT drive.
4. Use the standard PC tools to delete the file from the EGT drive or move the file to a new location.

This action removes all stored data from the Tester.

How to Troubleshoot

Follow the steps in Table 6. See Figure 11 for steps 1-5.

Table 6. Troubleshooting

Step	Description
1.	<p>External voltage (U_{ext}) too high</p> <p>If the external voltage applied to the instrument is too high, usually from leakage currents in the system under test, no measurement can be started (see <i>Specifications</i> for U_{ext} limit).</p> <p><i>Hint:</i> Reposition probe (S/P2) and restart measurement.</p>
2.	<p>Auxiliary earth electrode resistance (R_H) too high</p> <p>If the auxiliary earth electrode resistance is too high it is not possible to drive the current necessary for reliable measurements. The measurement is blocked (see <i>Specifications</i> for R_H limit).</p> <p><i>Hint:</i> Check connection of test lead with terminal H/C2, check auxiliary earth stake.</p>
3.	<p>Probe resistance (R_s) too high</p> <p>If the probe resistance is too high measurements are not reliable. The measurement is blocked (see <i>Specifications</i> for R_s limit).</p> <p><i>Hint:</i> Check connection of test lead with terminal S/P2, check probe stake.</p>
4.	<p>Weak batteries</p> <p>If the batteries are weak, the supply voltage may break down during measurement. If there is enough energy to complete the measurement “” symbol is displayed – measurement results are valid. If not, a reset occurs.</p> <p><i>Hint:</i> Replace batteries. Use 6 alkaline AA-type (LR6) batteries.</p>
5.	<p>Is your R_A measurement result reliable?</p> <p>Probe S/P2 must be outside the potential gradient areas of E/C1 and H/C2 for accurate measurements. Normally a probe distance of more than 20 m is sufficient. However, in some environmental conditions where the soil resistivity is variable, this may not be sufficient. To be sure, reposition the probes and take several measurements. If the readings are approximately the same, your measurement results are reliable. If not, increase the probe distance.</p>
6.	<p>Is the result of a “Stakeless ground loop measurement” reliable?</p> <p>Ensure that you have the correct inducing clamp (see <i>Accessories</i>).</p> <p>The clamp parameters are suited for this test method. An undefined clamp will give incorrect results.</p> <p>Ensure that the recommended minimum distance between the current clamp is kept. If the clamps are positioned too close together, the magnetic field of the inducing clamp will influence the sensing current clamp. To avoid mutual influencing, the distance between the clamps can be varied and a new test performed. If the measurement values vary only a little or not at all, the value can be regarded as reliable.</p>

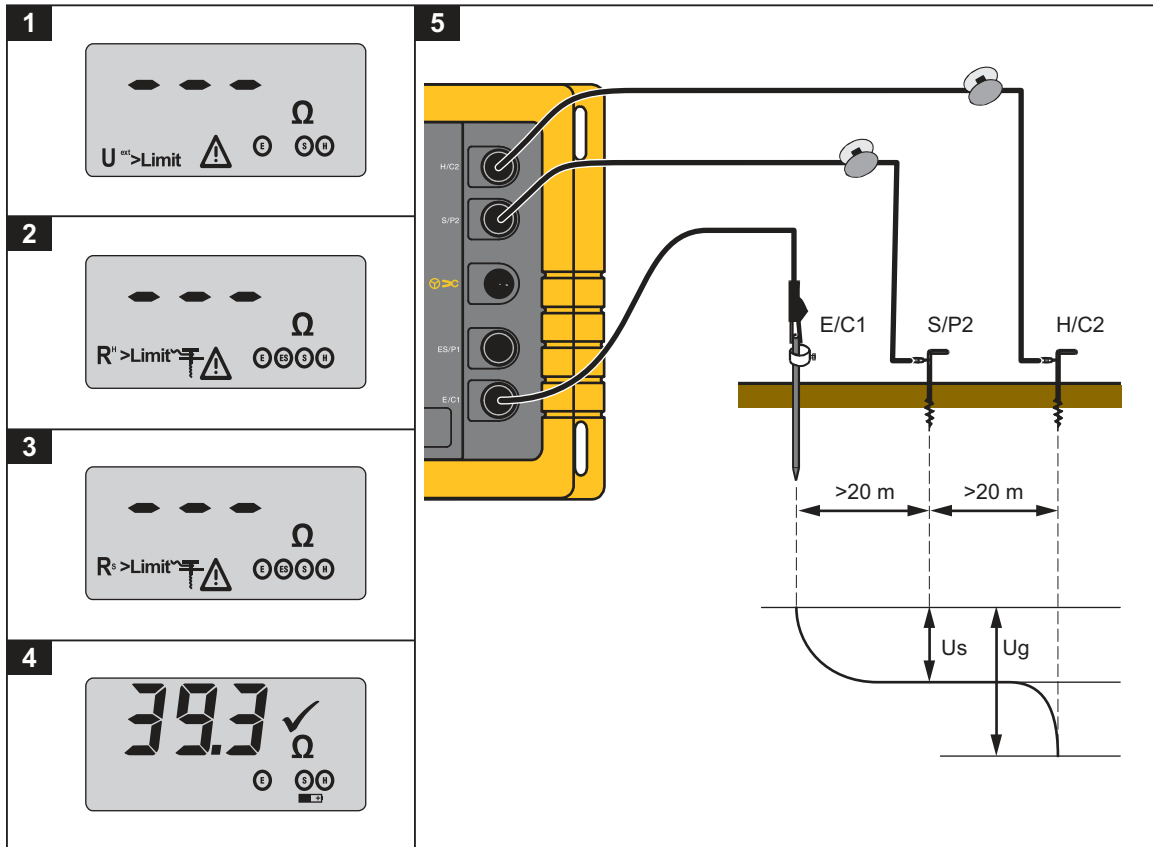

Figure 11. Troubleshooting

edv008.eps

Maintenance

If used and treated properly, the instrument needs no maintenance. To clean the instrument, use only a moist cloth with some soap water or soft household detergent or spirit. Avoid aggressive cleaning agents and solvents, such as trilene or chlorothene.

Service work must only be undertaken by trained qualified staff.

In all repair work care must be taken that the design parameters of the instrument are not modified to the detriment of safety, that assembled parts correspond to the original spares and that they are reassembled properly (factory state).

⚠️⚠️ Warning

To prevent possible electrical shock, fire, or personal injury:

- **Use only specified replacement parts.**
- **Have an approved technician repair the Product.**
- **The battery door must be closed and locked before you operate the Product.**
- **Replace the batteries when the low battery indicator shows to prevent incorrect measurements.**
- **Batteries contain hazardous chemicals that can cause burns or explode. If exposure to chemicals occurs, clean with water and get medical aid.**
- **Remove the input signals before you clean the Product.**

⚠️ Warning

For safe operation and maintenance of the Product:

- **Repair the Product before use if the battery leaks.**
- **Be sure that the battery polarity is correct to prevent battery leakage.**

Calibration

One-year calibration intervals are recommended.

Service

If you suspect that the Tester has failed, review this manual to make sure you are operating it correctly. If the meter still fails to operate properly, pack it securely (in its original container if available) and forward it, postage paid, to the nearest Fluke Service Center. Include a brief description of the problem. Fluke assumes NO responsibility for damage in transit.

To locate an authorized service center, go to www.fluke.com.

Specifications

Temperature ranges	
Operating temperature range:	0 °C to +35 °C (+32 °F to +95 °F)
Storage temperature range:	-20 °C to +60 °C (-4 °F to +140 °F)
Temperature coefficient:	±0.1 % of rdg / °C (below 18 °C and above 28 °C)
Operating humidity:	<95 % RH noncondensing
Operating altitude:	2000 m
Climatic class:	C1 (IEC 654-1), -5 °C to +45 °C, 5 % to 95 % RH
Protection type	
Case:	IP56
Battery door:	IP40
Electromagnetic compatibility:	Complies with IEC61326-1: Portable
Safety:	Complies with IEC 61010-1: CAT None, Pollution Degree 2
External voltage:	U_{ext} , max = 24 V (dc, ac < 400 Hz), measurement inhibited for higher values
Noise rejection:	>120 dB (162/3, 50, 60, 400 Hz)
Measurement time:	6 seconds, typical
Maximum overload:	250 V _{rms} (pertains to misuse)
Batteries:	6 x 1.5 v, AA, LR6 Alkaline
Battery life span:	>3000 measurements, typical
Dimensions:	240 mm x 180 mm x 110 mm (9.5 in x 7.1 in x 4.4 in)
Weight with batteries:	1.49 kg (3.28 lb)
Memory:	Internal memory storage up to 1500 records accessible via USB port

RA 3-Pole and 4-Pole ground resistance measurement

Resolution	Measurement range	Accuracy	Operating error
0.001 ... 10 Ω	0.020 Ω to 19,99 kΩ	±(2 % rdg + 3 d)	±(5 % rdg + 3 d)

Note

For 2-pole measurements, connect terminals H and S with the supplied connector cable.

Measurement principle: Current and voltage measurement

Measurement voltage:	Um = 48 V ac
Short-circuit current:	> 50 mA ac
Meas. frequency:	128 Hz
Probe resistance (Rs):	max 100 kΩ
Auxiliary earth electrode resistance (RH):	max 100 kΩ
Additional error from RH and RS:	$R_H[k\Omega] \cdot R_S[k\Omega]/R_a[\Omega] \cdot 0.2 \%$

RA 3-Pole and 4-Pole selective ground resistance measurement with current clamp (RA \gg C)

Resolution	Measurement range	Accuracy	Operating error
0.001 to 10 Ω	0.020 Ω to 19.99 kΩ	±(7% rdg + 3 d)	±(10% rdg + 5 d)

Measurement principle: Current/voltage measurement (with external current clamp)

Measurement voltage:	Um = 48 V ac
Short-circuit current:	> 50 mA ac
Measurement frequency:	128 Hz
Probe resistance (Rs):	max 100 kΩ
Auxiliary earth electrode resistance (Rh):	max 100 kΩ

Stakeless ground loop measurement (⊕ ⊖)

Resolution	Measurement range	Accuracy	Operating error
0.001 to 0.1 Ω	0.020 Ω to 199.9 Ω	±(7% rdg + 3 d)	±(10% rdg + 5 d)

Measuring principle: Stakeless measurement of resistance in closed loops using two current clamps

Measurement voltage:	Um = 48 V ac (primary)
Measurement frequency:	128 Hz
Noise current (I _{ext}):	max I _{ext} = 10 A (ac) (Ra < 20 Ω) max I _{ext} = 2 A (ac) (Ra > 20 Ω)

The information about stakeless ground loop measurements is only valid when used in conjunction with the recommended current clamps at the minimum distance specified.

