

FLUKE®

368/368 FC

369/369 FC

AC Leakage Current Clamp

Users Manual

November 2015 Rev. 1, 6/19

©2015-2019 Fluke Corporation. All rights reserved.

Specifications are subject to change without notice.

All product names are trademarks of their respective companies.

LIMITED WARRANTY AND LIMITATION OF LIABILITY

This Fluke product will be free from defects in material and workmanship for one year from the date of purchase. This warranty does not cover fuses, disposable batteries, or damage from accident, neglect, misuse, alteration, contamination, or abnormal conditions of operation or handling. Resellers are not authorized to extend any other warranty on Fluke's behalf. To obtain service during the warranty period, contact your nearest Fluke authorized service center to obtain return authorization information, then send the product to that Service Center with a description of the problem.

THIS WARRANTY IS YOUR ONLY REMEDY. NO OTHER WARRANTIES, SUCH AS FITNESS FOR A PARTICULAR PURPOSE, ARE EXPRESSED OR IMPLIED. FLUKE IS NOT LIABLE FOR ANY SPECIAL, INDIRECT, INCIDENTAL OR CONSEQUENTIAL DAMAGES OR LOSSES, ARISING FROM ANY CAUSE OR THEORY. Since some states or countries do not allow the exclusion or limitation of an implied warranty or of incidental or consequential damages, this limitation of liability may not apply to you.

Fluke Corporation
P.O. Box 9090
Everett, WA 98206-9090
U.S.A.

Fluke Europe B.V.
P.O. Box 1186
5602 BD Eindhoven
The Netherlands

ООО «Флюк СИАЙЭС»
125167, г. Москва, Ленинградский
проспект дом 37,
корпус 9, подъезд 4, 1 этаж

Table of Contents

Title	Page
Introduction	1
How to Contact Fluke	2
Safety Information	2
Product Overview	3
The Display	6
Manual-Range Mode	8
Clean the Product	8
Maintenance	9
Replacement Parts	9
Specifications	10
General	10
Electrical Specifications	11
AC Current Measurement	12
Environmental Specifications	13
Safety Specifications	14
Wireless Radio	15
Operational Error for Current	15
Product Functions	17

368/368 FC/369/369 FC

Users Manual

Introduction

The 368/368 FC and 369/369 FC AC Leakage Current Clamp (the Product) is a handheld tool for measurement of ac leakage current.

Principle of Leakage Current Measurement

Based on the electromagnetic induction principle, the Product has a ring-shape current transformer comprised of a metal core and coil winding. The current transformer senses the magnetic field produced by the current or by the vector sum of the currents flowing in the conductor under test. The current transformer then produces a current proportional to the current flowing in the conductor.

See the *Product Functions* section near the end of this manual.

How to Contact Fluke

To contact Fluke, call one of the following telephone numbers:

- Technical Support USA: 1-800-44-FLUKE (1-800-443-5853)
- Calibration/Repair USA: 1-888-99-FLUKE (1-888-993-5853)
- Canada: 1-800-36-FLUKE (1-800-363-5853)
- Europe: +31 402-675-200
- Japan: +81-3-6714-3114
- Singapore: +65-6799-5566
- China: +86-400-921-0835
- Brazil: +55-11-3530-8901
- Anywhere in the world: +1-425-446-5500

Or, visit Fluke's website at www.fluke.com.

To register your product, visit <http://register.fluke.com>.

To view, print, or download the latest manual supplement, visit <http://us.fluke.com/user/support/manuals>.

Safety Information

General Safety Information is in the printed Safety Information document that ships with the Product and at www.fluke.com. More specific safety information is listed where applicable.

Product Overview

Table 1 and Figure 1 explain the Product features.

Table 1. Features

Item	Definition
1	Keep fingers below the Tactile Barrier .
2	Push HOLD to retain the measured data on the display. When pushed, HOLD shows on the display. When pushed again, data hold is canceled and HOLD disappears.
3	The display shows the measured value (digital reading), unit, function, and low battery symbol.
4	Push mA/A to choose the range of ac current (either mA or A). Push and hold mA/A for 2 seconds to turn on the filter.
5	368 FC/369 FC: Log data and clear memory, see <i>Product Functions</i> .
6	368 FC/369 FC: Turn on/turn off the Fluke Connect™ wireless connectivity to a smartphone, see <i>Product Functions</i> .

Table 1. Features (cont.)





Item	Definition
7	Push  to show the minimum, maximum, and average reading. When pushed,  shows on the display.
8	Push  to turn on the display backlight. Push and hold  for 2 seconds to turn on the spotlight. See <i>Spotlight</i> .
9	Push  to turn on or turns off the Product.
10	Jaw trigger
11	Push the jaw lock button and the trigger together to unlock the jaw.
12	Spotlight. See <i>Spotlight</i> .
13	Jaw
14	Battery Housing holds the batteries. See <i>Batteries</i> .

Figure 1. Product Features



The Display

Table 2 and Figure 2 explain the Product display.

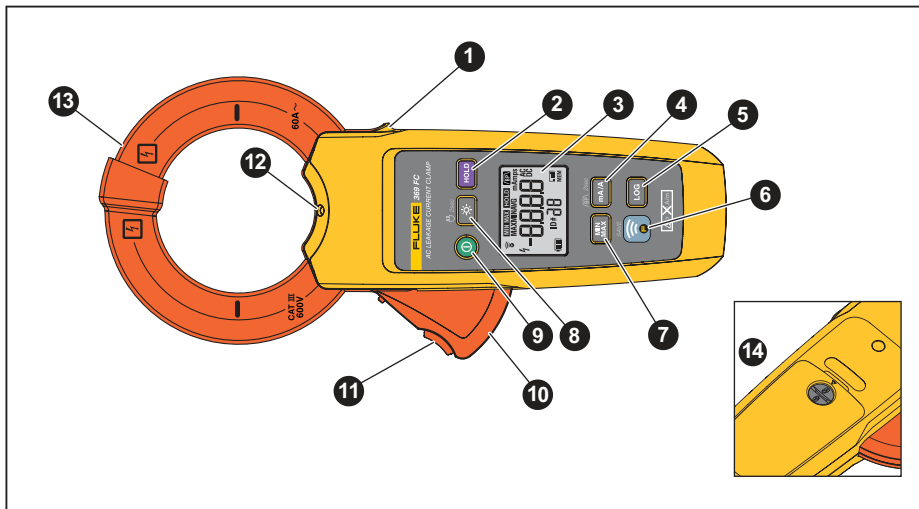
Table 2. Display

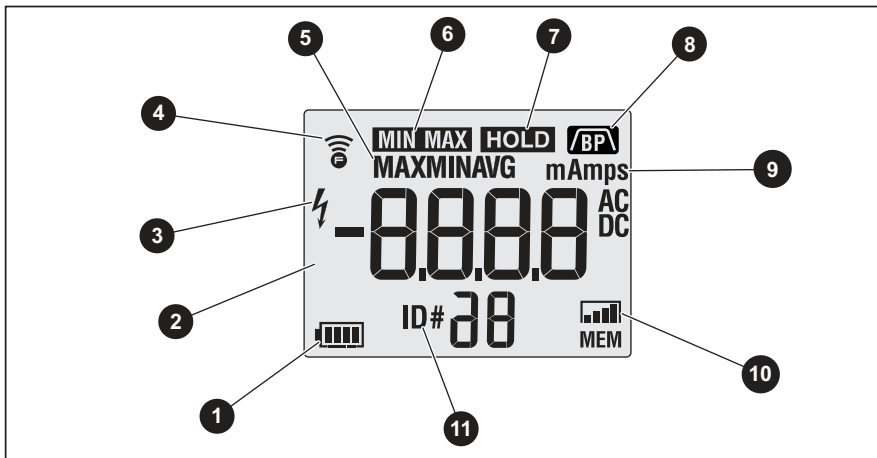

Item	Definition
1	Battery Symbol
2	Main display
3	The Product is searching for ranges.
4	Fluke Connect on (368 FC and 369 FC)
5	Min, Max, or Avg reading is showing.
6	MinMax mode is active.
7	Hold mode is active.
8	Filter is active and filters signals from 40 Hz – 70 Hz.
9	mAAC or AAC
10	Remaining memory (368 FC and 369 FC)
11	Product identification number when used with Fluke Connect (368 FC and 369 FC).

Figure 2. Display



Manual-Range Mode

To enable manual-range mode:

1. With the Product off, simultaneously push  and .
2. Hold both buttons until the backlight illuminates (~2 s).
The Product is now in manual-range mode.
3. Push  to select the range.

Clean the Product

Periodically wipe the case with a damp cloth and mild detergent.

Caution

To avoid damaging the Product, do not use abrasives or solvents to clean the Product.

1. Inspect the jaw mating surface for cleanliness. If any foreign material is present, the jaw will not close properly and measurement errors will result.
2. Open the jaws and clean the clamp metal ends with a lightly oiled cloth.

Maintenance

If the Product does not work or perform properly, use these steps to help isolate the problem:

1. Inspect the jaw mating surface for cleanliness. If any foreign material is present, the jaw will not close properly and measurement errors will result.
2. Verify that the range on the Product is correct.

Replacement Parts

Replacement parts are listed in Table 3. To order, see *How to Contact Fluke*.

Table 3. Replacement Parts

Item	Description	Fluke Part Number
Battery	2AA IEC LR6 Alkaline	376756
Battery door assembly	English	4700598
	Chinese	4739829

Specifications

General

Measurement functions	AC current
Display (LCD)	Digital reading: 3300 counts, LCD refresh rate 4x/s
Range selection.....	mA/A: manual selection 3 mA/30 mA/300 mA: auto selection 3 A/30 A/60 A: auto selection
Battery	
Type	2 AA IEC LR6 alkaline
Life.....	>150 hours without backlight and spotlight
Maximum conductor diameter	368: 40 mm, 369: 61 mm
Automatic power off.....	15 minutes after the last switch operation

Dimensions

369/369 FC (W x H x D)..... 116 mm x 257 mm x 46 mm

368/368 FC (W x H x D)..... 101 mm x 234 mm x 46 mm

Weight

369/369 FC..... 600 g

368/368 FC..... 500 g

Electrical Specifications

Reference Conditions.....23 ±5 °C and 80 % RH maximum

A AC Range 3 mA, 30 mA, 300 mA, 3 A, 30 A, 60 A

Frequency40 Hz to 1 kHz

Crest Factor.....3

368/368 FC/369/369 FC

Users Manual

AC Current Measurement

Accuracy is specified for 1 year after calibration. Accuracy is given as \pm (% reading + digit).

Range	Resolution	368/368 FC		369/369 FC		T.C./°C Outside 18 °C to 28 °C
		Filter On (40-70 Hz)	Filter Off (40-1 kHz)	Filter On (40-70 Hz)	Filter Off (40-1 kHz)	
3 mA ^[1]	0.001 mA	1+5	1+5	1.5+5	1.5+5	0.002+1
30 mA	0.01 mA	1+5	1+5	1.5+5	1.5+5	0.002+1
300 mA	0.1 mA	1+5	1+5	1.5+5	1.5+5	0.002+1
3 A	0.001 A	1+5	1+5	1.5+5	1.5+5	0.002+1
30 A	0.01 A	1+5	1+5	1.5+5	1.5+5	0.002+1
60 A	0.1 A	2+5	2+5	2+5	2+5	0.002+1

[1] The minimum value is 10 μ A rms.

Environmental Specifications

Operating temperature -10 °C to +50 °C

Storage temperature -40 °C to +60 °C

Operating humidity

(without condensation) Non condensing (<10 °C)
90 % RH (10 °C to 30 °C)
75 % RH (30 °C to 40 °C)
45 % RH (40 °C to 50 °C)

Ingress Protection IEC 60529: IP30 with jaw closed

Operating Altitude..... 2000 m

Storage Altitude..... 12 000 m

Electromagnetic Compatibility (EMC)

International..... IEC 61326-1: Industrial Electromagnetic Environment
IEC 61326-2-2, CISPR 11: Group 1, Class B

Group 1: Equipment has intentionally generated and/or uses conductively-coupled radio frequency energy that is necessary for the internal function of the equipment itself.

Class B: Equipment is suitable for use in domestic establishments and in establishments directly connected to a low voltage power supply network which supplies buildings used for domestic purposes.

Emissions that exceed the levels required by CISPR 11 can occur when the equipment is connected to a test object.

Korea (KCC)..... Class A equipment (Industrial Broadcast & Communications Equipment)

Class A: Equipment meets requirements for industrial electromagnetic wave equipment and the seller or user should take notice of it. This equipment is intended for use in business environments and not to be used in homes.

USA (FCC) 47 CFR 15 subpart B. This product is considered an exempt device per clause 15.103.

Safety Specifications

General..... IEC61010-1: Pollution degree 2

Measurement IEC61010-2-032: CAT III 600 V

Current Clamp for Leakage Current

Measurements..... IEC 61557-13: Class 2, ≤ 30 A/m

Wireless Radio

Radio Frequency Certification FCC ID:T68-FBLE IC:6627A-FBLE

Frequency Range 2405 MHz to 2480 MHz

Output Power <100 mW

Radio Frequency Data Go to www.fluke.com and search for “Radio Frequency Data for Class A” (PN 4333628)

Operational Error for Current

Accuracy is specified for 1 year after calibration. Accuracy is given as \pm (% reading).

Accuracy guaranteed for 50 Hz and 60 Hz.

Parameter	Specification	Typical		Max ^[1]	
		368/368 FC	369/369 FC	368/368 FC	369/369 FC
Intrinsic Uncertainty	IEC 61557-13 A Reference conditions	0.08 %	0.06 %	0.15 %	0.13 %
Conductor Position	IEC 61557-13 E1 $\pm 30^\circ$	0.08 %	0.06 %	0.15 %	0.12 %
Battery Voltage	IEC 61557-13 E2 2.0 V to 3.3 V	0.08 %	0.05 %	0.15 %	0.12 %
Temperature	IEC 61557-13 E3 -10 °C to 50 °C	0.14 %	0.14 %	0.29 %	0.29 %
Distortion	IEC 61557-13 E9	0.06 %	0.07 %	0.15 %	0.12 %



368/368 FC/369/369 FC

Users Manual

Parameter	Specification	Typical		Max ^[1]	
		368/368 FC	369/369 FC	368/368 FC	369/369 FC
Magnetic Field	IEC 61557-13 E11 (15 Hz to 400 Hz) 10 A/m Class 3 30 A/m Class 2	1.58 % 4.75 %	2.07 % 6.21 %	3.54 % 10.61 %	3.31 % 9.96 %
Load Current	IEC 61557-13 E12 60 A rms max (50 Hz and 60 Hz)	3.60 %	5.17 %	7.67 %	10.83 %
Touch Current	IEC 61557-13 E13 CAT III 600 V/ 60 Hz	0.94 %	0.06 %	1.61 %	0.14 %
Frequency	IEC 61557-13 E14 40 Hz to 1 kHz	0.15 %	0.15 %	0.30 %	0.32 %
Repeatability	IEC 61557-13 E15	0.08 %	0.06 %	0.15 %	0.12 %
Uncertainty	IEC 61557-13 B 10A/m Class 3 30A/m Class 2	4.74 % 7.02 %	6.47 % 9.36 %	10.06 % 15.34 %	13.16 % 17.05%

[1] Confidence level: 95 %.

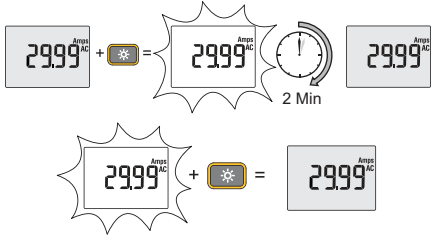
Product Functions

Auto Power Off	Backlight
 <p>15 Min</p>	 <p>2 Min</p>
 <p>MIN MAX + Power On + HOLD = Poff</p>	 <p>MIN MAX + Power On + Sun = Loff</p>

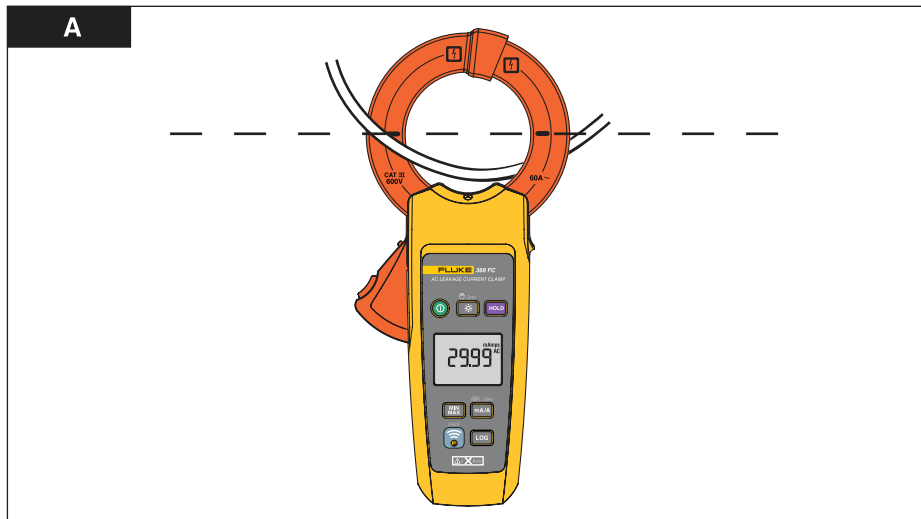

Measure

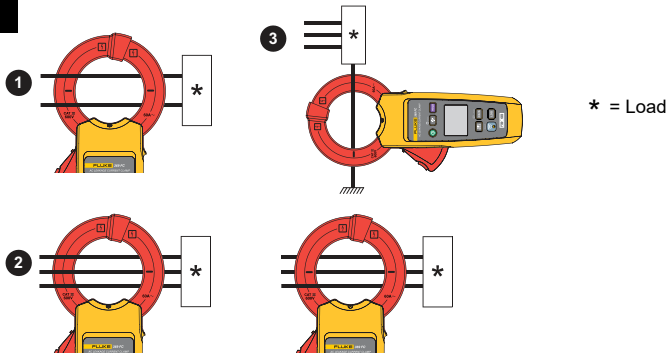

1	Single-Phase Two-Wire Circuit
2	Single-Phase Three-Wire or Three-Phase Three-Wire Circuit
3	Load Current Measurement. Insert only one of the wires through the jaw.

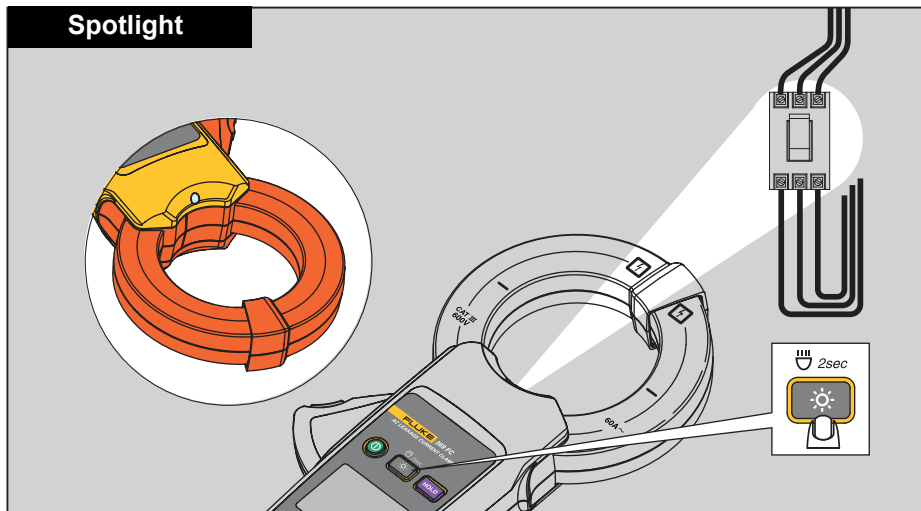

AC Leakage Current Clamp

Product Functions

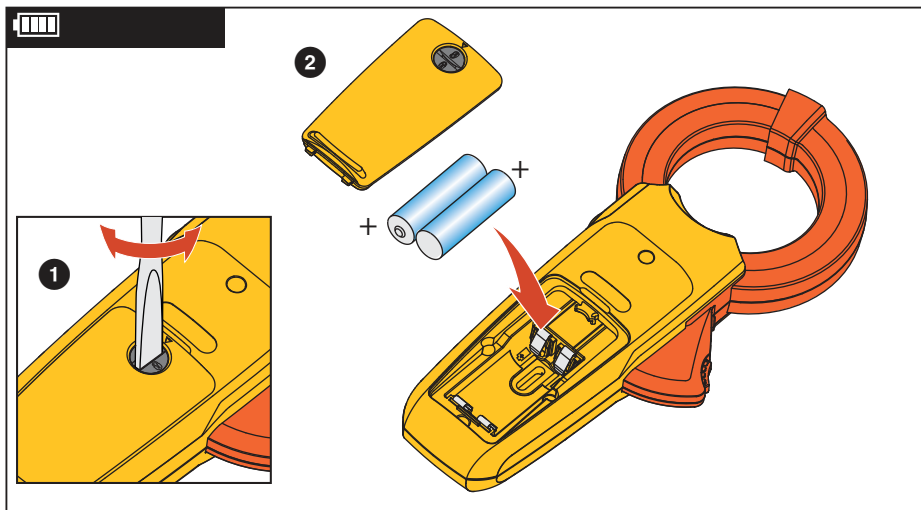

Fluke Connect™ Bluetooth Connection to FC Tools

